



---

# Triconex 3625

---

Datasheet

---

By Cambia Group

---

Contact Email: [sales@cambia.cn](mailto:sales@cambia.cn)

# Table of contents

	Page
1. <b>General Description</b> .....	1- 0
2. <b>3503E / 3505E</b> Application (16+16DI) .....	2- 0
3. <b>3504E / 3564</b> Application (32DI) .....	3- 0
4. <b>3511</b> Application (In preparation) .....	4- 0
5. <b>3604E / 3624</b> Application (16DO).....	5- 0
6. <b>3664</b> Application (16+16DO).....	6- 0
7. <b>3703E</b> Application (16AI).....	7- 0
8. <b>3700 / 3700A / 3701 / 3721</b> Application (16+16AI).....	8- 0
9. <b>3704E / 3720</b> Application (32+32AI).....	9- 0
10. <b>3805E</b> Application (8AO).....	10- 0
11. <b>Cabinet assembly</b> .....	11- 0
12. <b>Accessories</b> .....	12- 0
13. <b>Test certificate</b> .....	13- 0

# 1. General Description

	Page
Motherboard for 16 modules .....	1- 1
Motherboard for 8 modules .....	1- 2
Installation instructions .....	1- 3
Power supply block diagram .....	1- 4
ELCO connector.....	1- 5
ISTA with Galvanic Isolated Modules List index.....	1- 6

email: sales@cambia.it

The standard motherboard is designed for 8 or 16KF modules Power feed and system connector to DCS are integrated in the motherboard, which results in noticeable space savings in the interface cabinet. The power source has a redundant design, increasing the reliability of the system. The operating status of the power supply is monitored and reported via led and relay output.

The KF modules are interfaced to the motherboard himself by using 2- to 6- pin coded cable connectors.(FSY...) The motherboard configuration is mounted on a stable metal plate. There are two brackets, on the back for mounting the board quickly and easily to a standard DIN rail in accordance with DIN EN 50022 or similar.

### 1. Model with 16 modules

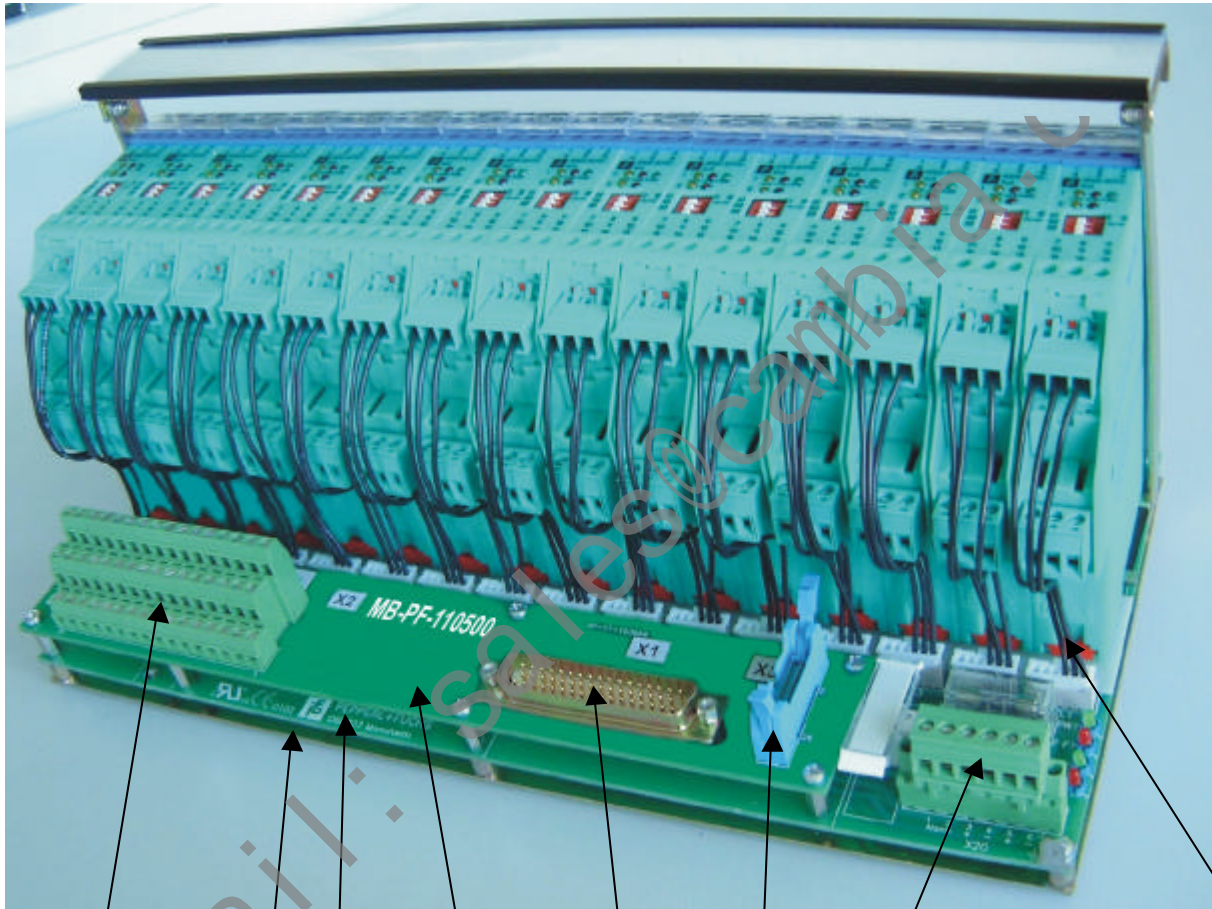

- Optional second connector for redundant connection to PLC
- Adapter
- Main printed circuit board
- Customer specified system plug to PLC
- Terminal strip (removable) for redundant power supply and message contact for monitoring the power, optional breakage and short circuit monitoring.
- Cable connector (FSY) between the modules and the PCB
- Metal base plate with brackets for mounting on DIN rail
- Connector for HART communication

Urheberrecht nach DIN 34  
Weitergabe sowie Vervielfältigung ist nicht gestattet

	<b>PEPPERL+FUCHS</b> Mannheim-Schönau		<b>Motherboard for 16 Modules</b> <u>General description</u>		23.02.01			vB		
					Datum	S	TZ	Sach- bearb.	gepr. techn.	gepr. Norrr
					Abt.: PA-VP			Word		
					XXXXXX			Ersatz für :		Blatt 1
			Maßstab:		von 2					

## 2. Model with 8 modules

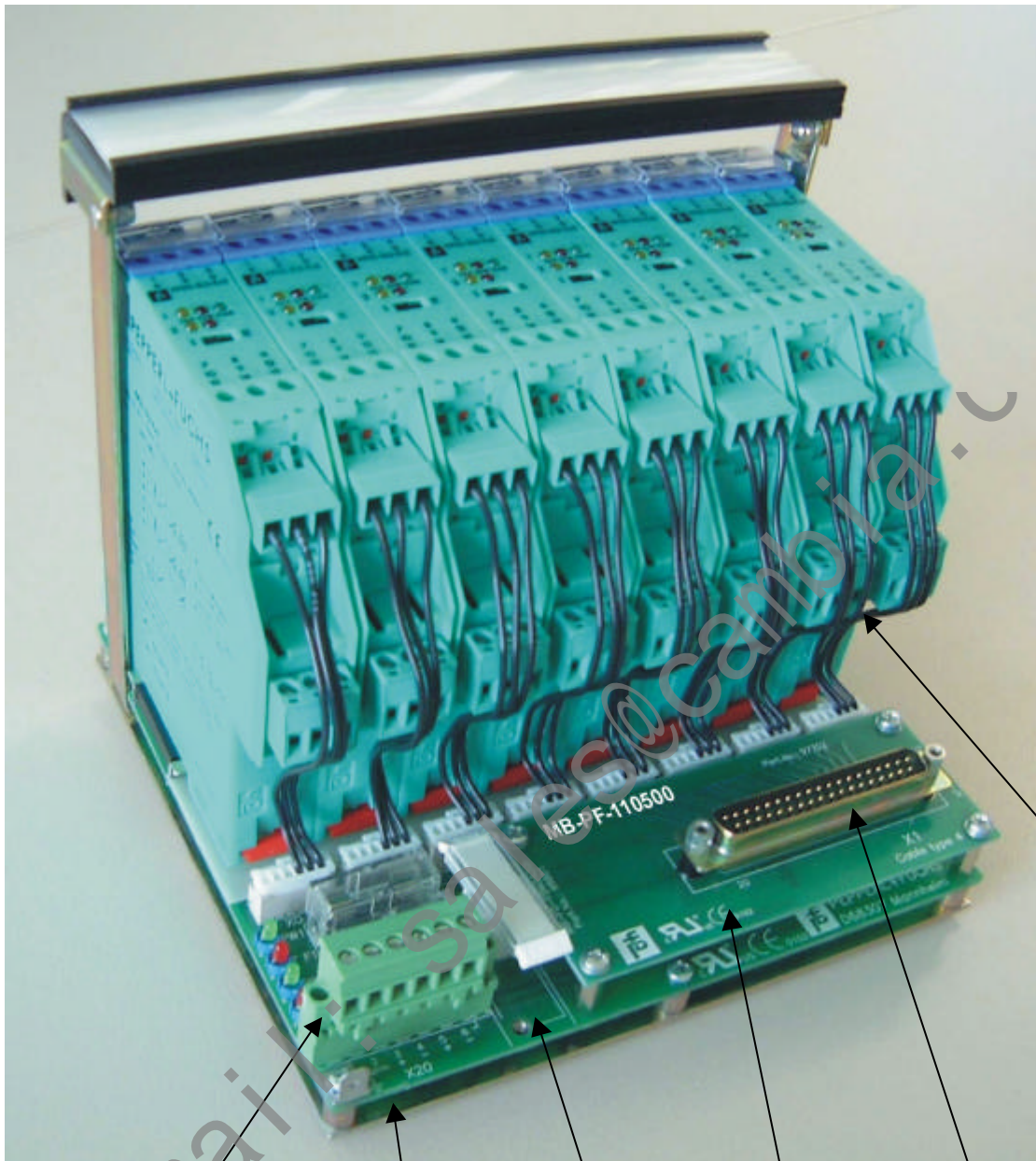

Terminal strip (removable) for redundant power supply and message contact for monitoring the power, optional breakage and short circuit monitoring.

Metal base plate with brackets for mounting on DIN rail

Main printed circuit board

Adapter

Customer specified system plug to PLC

Cable connector (FSY) between the modules and the PCB

Urheberrecht nach DIN 34  
Weitergabe sowie Vervielfältigung ist nicht gestattet

	<b>PEPPERL+FUCHS</b> Mannheim-Schönau	<b>Motherboard for 8 Modules</b> <u>General description</u>	06.02.02			KT			
			Datum	S	TZ	Sachbearb.	gepr. techn.	gepr. Norm	
			Abt.: PA-VP	Word					
			Part.Nr.: xxxxxx	Ersatz für :				Blatt 2	
				Maßstab:		von 2			

# Installations instructions

1. Take away first and last module.  
Operate the screw to fix the board on to the DIN rail.

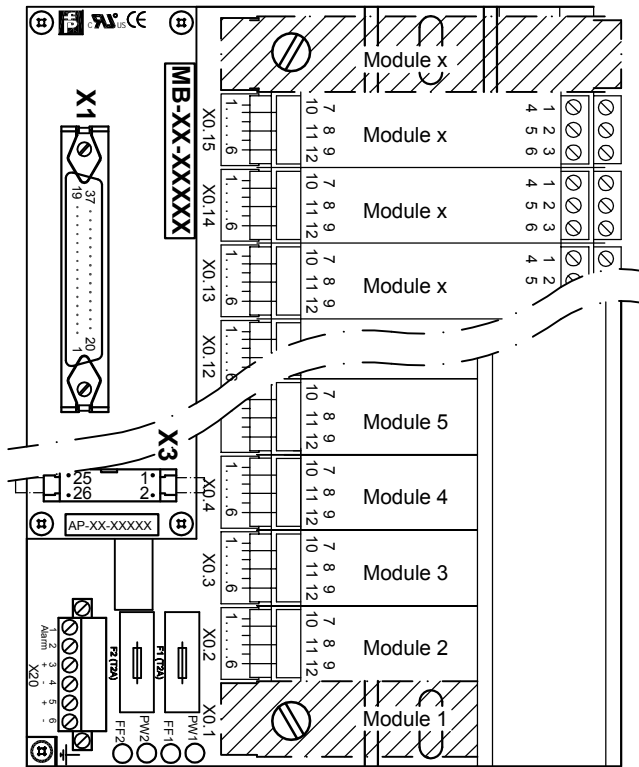

2. Turn the part as shown the stopper!

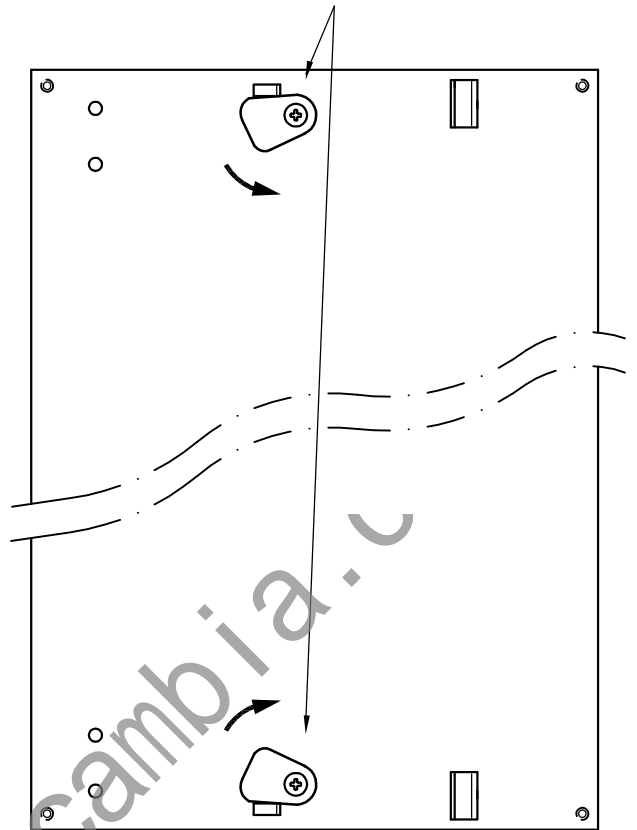

3. Set the board on the DIN rail. Turn the screw as shown till the board is fixed.  
(Arrows are showing direction how to turn for fixing the board)

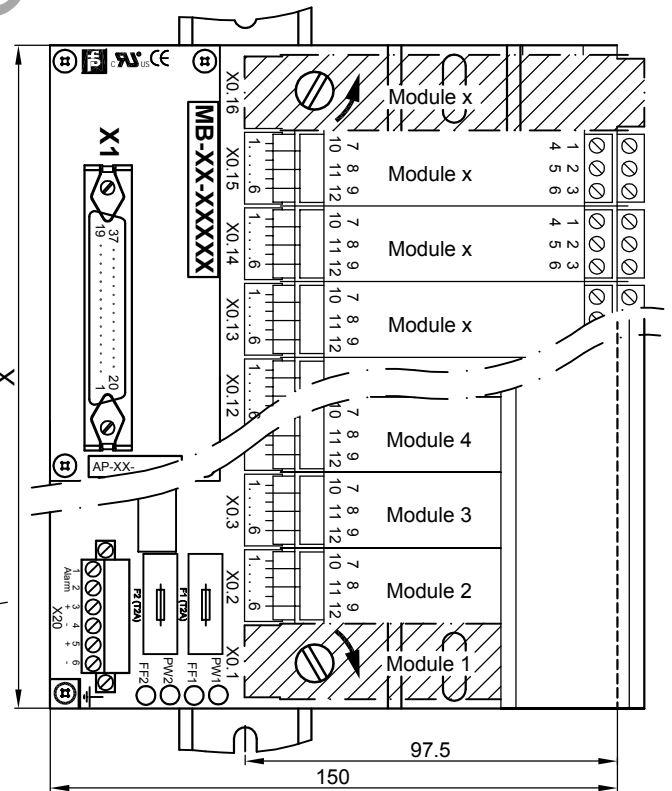
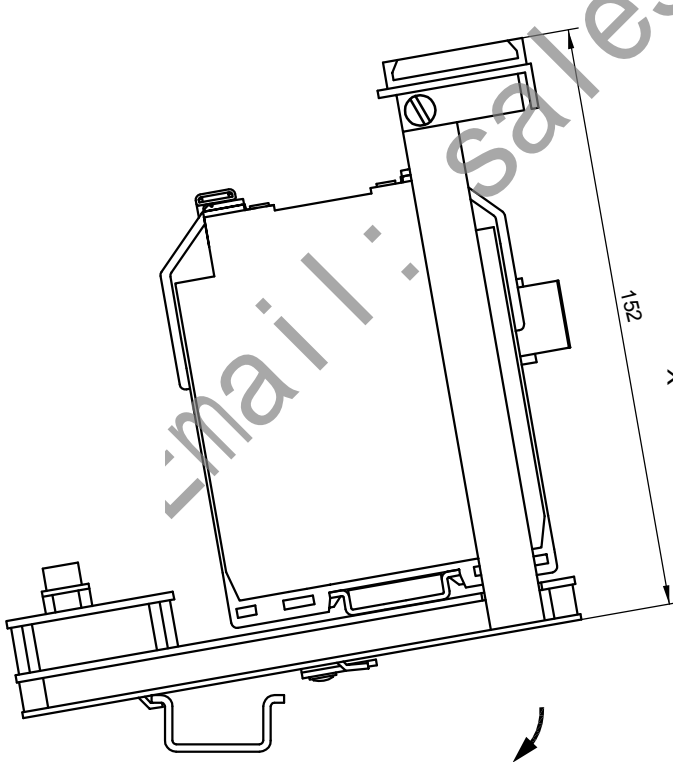

copyright according to DIN34  
unauthorized distribution and reproduction prohibited



PEPPERL+FUCHS  
Mannheim-Schönau

Installations instructions  
for Motherboards installed  
in vertical position

07.09.01	KT	vB	Sb/vB		
Date	S	TD	Off. in ch.	contr. techn.	contr. Norm
Dept.: PA-VP	Sch/Br		No. <b>36-9159A1</b>		
Up date: 02.02.04	Replaces:		xxxxxx / 36-xxxx	Sheet 1	
	Scale:		-	of 1	

# Block diagram power supply and error message

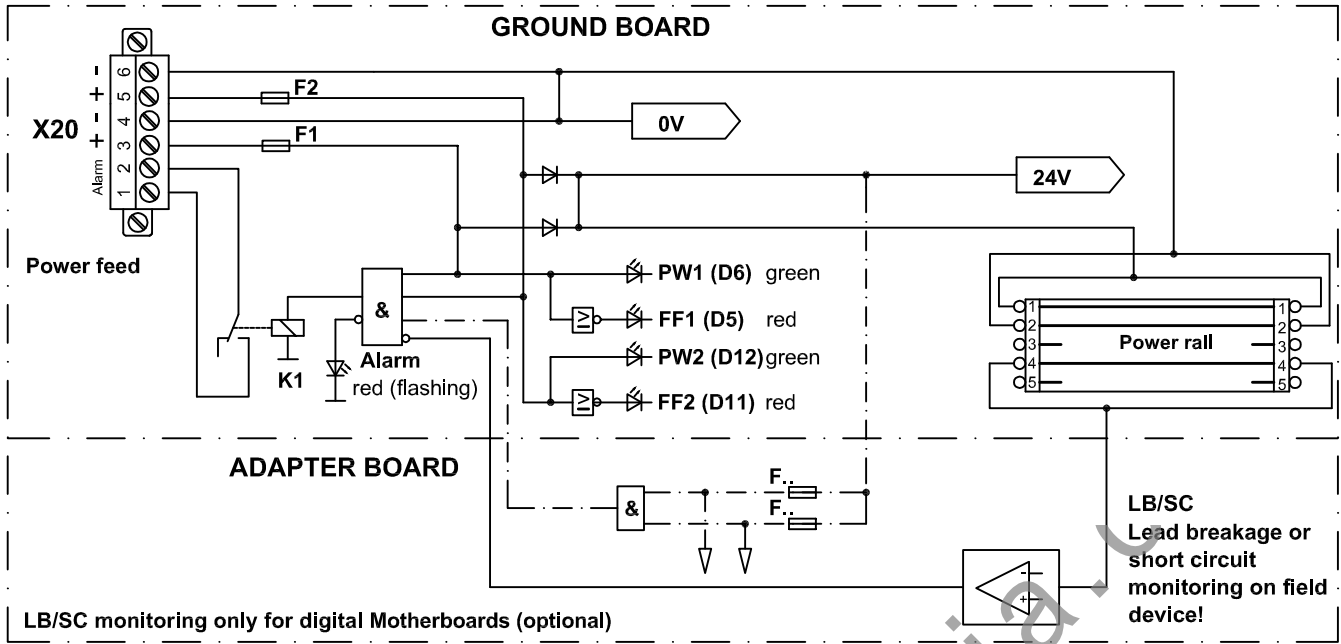

# Connection power supply and error message

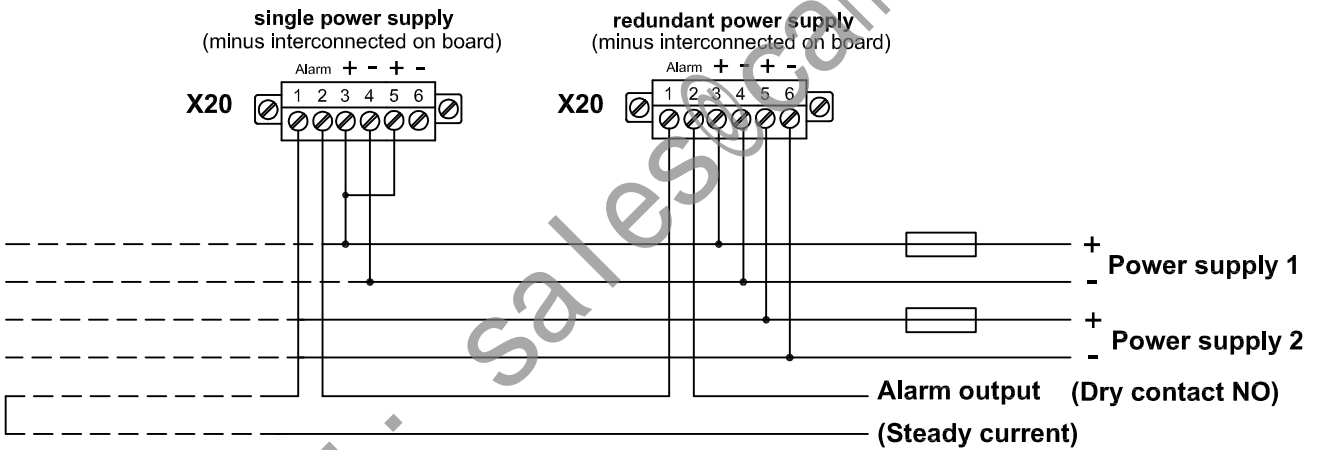

# Error message and Alarm

Power supply 1	Power supply 2	LED red	LED green	X20.1, 2 Alarm contact
PS ON and Fuse 1 OK	PS ON and Fuse 2 OK	D5 OFF D11 OFF	D6 ON D12 ON	contact closed
PS ON and Fuse 1 OK	PS OFF	D5 OFF D11 ON	D6 ON D12 OFF	contact open
PS OFF	PS ON and Fuse 2 OK	D5 ON D11 OFF	D6 OFF D12 ON	contact open
PS ON and Fuse 1 OK	PS ON and Fuse 2 broken	D5 OFF D11 ON	D6 ON D12 OFF	contact open
PS ON and Fuse 1 broken	PS ON and Fuse 2 OK	D5 ON D11 OFF	D6 OFF D12 ON	contact open
PS ON and Fuse 1 broken	PS ON and Fuse 2 broken	D5 OFF D11 OFF	D6 OFF D12 OFF	contact open
PS OFF	PS OFF	D5 OFF D11 OFF	D6 OFF D12 OFF	contact open
In case of LB/SC				contact open

copyright according to DIN34 unauthorized distribution and reproduction prohibited

<b>PEPPERL+FUCHS</b> Mannheim-Schönau	Block diagram Power supply monitoring Error message LB/SC <b>MOTHERBOARD MB-4/8/12/16</b>	04.04.01	vB	Sb	vB/Sb		
		Date	S	TZ	Off. in ch.	contr. techn.	contr. Norm
		Dept.: PA-PG-IF	Nr. <b>36-7143F1</b>				
		Up date: 21.04.2010	Replaces: xxxxxxxx/ 36-xxxx	Sheet 1			
		xxxxx	Scale:	X : X	of	1	

# ELCO female connector

Pin arrangement of the 56 pin ELCO connector  
(female)

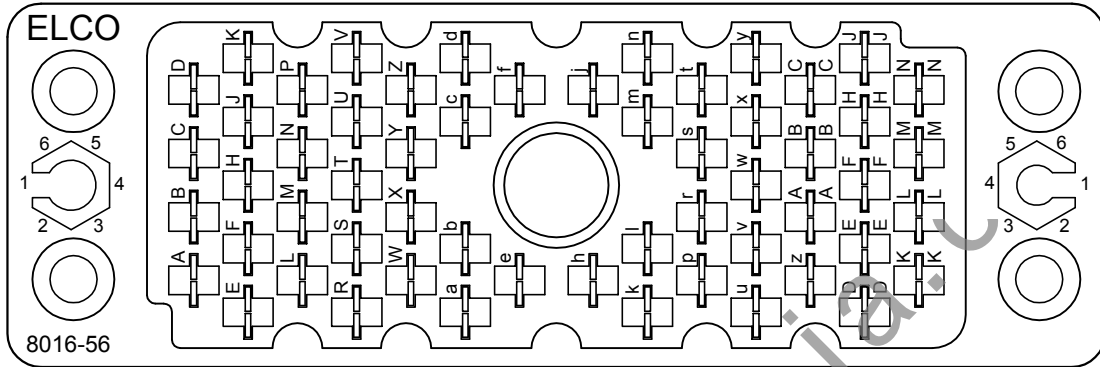

Large Key

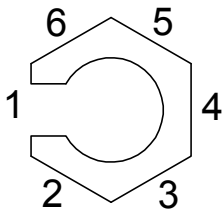

Small Key

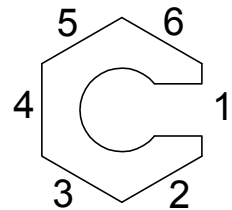

## Coding for Triconex system cable

Signal	Large key position	Small key position
AI	5	1
AO	5	3
DI	3	1
DO	3	3

04.04.02		KT	Sb	Sb	
Date	S	TZ	Off. in ch.	contr. techn.	contr. Norm.
Dept.: PA-VP			Nr. <b>36-9227</b>		
Up date: vB/Bro 17.03.04		Replaces: xxxxxx / 36-xxxx		Sheet 1	
Scale: - : -				of 1	



PEPPERL+FUCHS  
Mannheim-Schönau

**ELCO connector**  
for Triconex system cable



## Intrinsic Safety Termination Assemblies With Galvanic Isolators

Triconex • I/O card number • Signal type	P+F Motherboard • Order name • Part No. • Drawing No.	Description • Module • Motherboard • Dimensions
3503E / 3505E (16 + 16 DI)	<ul style="list-style-type: none"> <li>• ISTA-TR-DI-SH-350X-118289</li> <li>• Part No. 118289</li> <li>• Drawing No. 36-7443</li> </ul>	<u>Module:</u> • type KFD2-SH-Ex1.T.OP, single channel, (DI-Fail Safe) <u>Motherboard:</u> • 16 modules (16 channels) • 1 ELCO 56 pin, female system connector • LB/SC monitoring on separate screw terminal <u>Dimensions (wxhxd) :</u> • 325x150x150 mm
	<ul style="list-style-type: none"> <li>• ISTA-TR-DI-SRLB-350X-122110</li> <li>• Part No. 122110</li> <li>• Drawing No. 36-7417</li> </ul>	<u>Module:</u> • type KFD2-SR2-Ex1.W.LB, single channel, (DI) <u>Motherboard:</u> • 16 modules (16 channels) • 1 ELCO 56 pin, female system connector • LB/SC monitoring on separate screw terminal <u>Dimensions (wxhxd) :</u> • 325x150x150 mm
	<ul style="list-style-type: none"> <li>• ISTA-TR-DI-SR2-350X-118271</li> <li>• Part No. 118271</li> <li>• Drawing No. 36-7413</li> </ul>	<u>Module:</u> • type KFD2-SR2-Ex2.2S, dual channel, (DI) <u>Motherboard:</u> • 16 modules (16 + 16 channels) • 2 ELCO 56 pin, female system connector <u>Dimensions (wxhxd) :</u> • 325x150x150 mm
	<ul style="list-style-type: none"> <li>• ISTA-TR-DI-SOT2-350X-118272</li> <li>• Part No. 118272</li> <li>• Drawing No. 36-7169</li> </ul>	<u>Module:</u> • type KFD2-SOT2-Ex2, dual channel, (DI) <u>Motherboard:</u> • 16 modules (16 + 16 channels) • 2 ELCO 56 pin, female system connector <u>Dimensions (wxhxd) :</u> • 325x150x150 mm
3504E / 3564 (32 + 32 DI)	<ul style="list-style-type: none"> <li>• ISTA-TR-DI-SR2-35XX-118278</li> <li>• Part No. 118278</li> <li>• Drawing No. 36-7361</li> </ul>	<u>Module:</u> • type KFD2-SR2-Ex2.2S, dual channel, (DI) <u>Motherboard:</u> • 16 modules (32 channels) • 1 ELCO 56 pin, female system connector <u>Dimensions (wxhxd) :</u> • 325x150x150 mm
	<ul style="list-style-type: none"> <li>• ISTA-TR-DI-SOT2-35XX-118279</li> <li>• Part No. 118279</li> <li>• Drawing No. 36-7188</li> </ul>	<u>Module:</u> • type KFD2-SOT2-Ex2, dual channel, (DI) <u>Motherboard:</u> • 16 modules (32 channels) • 1 ELCO 56 pin, female system connector <u>Dimensions (wxhxd) :</u> • 325x150x150 mm
3511 (16 DI)	<ul style="list-style-type: none"> <li>• ISTA-TR-DI-SOT-3511-183387</li> <li>• Part No. 183387</li> <li>• Drawing No. 36-7697</li> </ul>	<u>Module:</u> • type KFD2-SOT2-Ex1.LW, single channel, (DI) <u>Motherboard:</u> • 8 modules (16 channels) • 1 ELCO 56 pin, female system connector <u>Dimensions (wxhxd) :</u> • 165x150x150 mm
3604E 3624 (16 DO)	<ul style="list-style-type: none"> <li>• ISTA-TR-DO-SD-36XX-118274</li> <li>• Part No. 118274</li> <li>• Drawing No. 36-7430</li> </ul>	<u>Module:</u> • type KFD2-SD-Ex1.48..., single channel, (DO) <u>Motherboard:</u> • 16 modules (16 channels) • 1 ELCO 56 pin, female system connector <u>Dimensions (wxhxd) :</u> • 325x150x150 mm
	<ul style="list-style-type: none"> <li>• ISTA-TR-DO-SL2-36XX-118273</li> <li>• Part No. 118273</li> <li>• Drawing No. 36-7363</li> </ul>	<u>Module:</u> • type KFD2-SL2-Ex2.B, dual channel, (DO) <u>Motherboard:</u> • 8 modules (16 channels) • 1 ELCO 56 pin, female system connector <u>Dimensions (wxhxd) :</u> • 165x150x150 mm
	<ul style="list-style-type: none"> <li>• ISTA-TR-DO-SL2-36XX-118288</li> <li>• Part No. 118288</li> <li>• Drawing No. 36-7358</li> </ul>	<u>Module:</u> • type KFD2-SL2-Ex2.B, dual channel, (DO) <u>Motherboard:</u> • 8 modules (16 channels) • 1 ELCO 56 pin, female system connector • LB/SC monitoring <u>Dimensions (wxhxd) :</u> • 165x150x150 mm
3664 (16 + 16 DO)	<ul style="list-style-type: none"> <li>• ISTA-TR-DO-SD-36XX-118274</li> <li>• Part No. 118274</li> <li>• Drawing No. 36-7430</li> </ul>	<u>Module:</u> • type KFD2-SD-Ex1.48..., single channel, (DO) <u>Motherboard:</u> • 16 modules (16 channels) • 1 ELCO 56 pin, female system connector <u>Dimensions (wxhxd) :</u> • 325x150x150 mm

## Intrinsic Safety Termination Assemblies With Galvanic Isolators

Triconex • I/O card number • Signal type	P+F Motherboard • Order name • Part No. • Drawing No.	Description • Module • Motherboard • Dimensions
	<ul style="list-style-type: none"> <li>• ISTA-TR-DO-SL2-36XX-118273</li> <li>• Part No. 118273</li> <li>• Drawing No. 36-7363</li> </ul>	<u>Module:</u> • type KFD2-SL2-Ex2.B, dual channel, (DO) <u>Motherboard:</u> • 8 modules (16 channels) • 1 ELCO 56 pin, female system connector <u>Dimensions (wxhxd):</u> • 165x150x150 mm
	<ul style="list-style-type: none"> <li>• ISTA-TR-DO-SL2-36XX-118288</li> <li>• Part No. 118288</li> <li>• Drawing No. 36-7358</li> </ul>	<u>Module:</u> • type KFD2-SL2-Ex2.B, dual channel, (DO) <u>Motherboard:</u> • 8 modules (16 channels) • 1 ELCO 56 pin, female system connector • LB/SC monitoring <u>Dimensions (wxhxd):</u> • 165x150x150 mm
3703E (16 AI)	<ul style="list-style-type: none"> <li>• ISTA-TR-AI-STC-370X-118275</li> <li>• Part No. 118275</li> <li>• Drawing No. 36-7463</li> </ul>	<u>Module:</u> • type KFD2-STC4-Ex1, single channel, (AI) <u>Motherboard:</u> • 16 modules (16 channels) • 1 ELCO 56 pin, female system connector • HART 26 pin, male connector <u>Dimensions (wxhxd):</u> • 325x150x150 mm
	<ul style="list-style-type: none"> <li>• ISTA-TR-AI-UT-370X-118276</li> <li>• Part No. 118276</li> <li>• Drawing No. 36-7175</li> </ul>	<u>Module:</u> • type KFD2-UT-Ex1, single channel, (AI) <u>Motherboard:</u> • 16 modules (16 channels) • 1 ELCO 56 pin, female system connector <u>Dimensions (wxhxd):</u> • 325x150x150 mm
3700 / 3700A / 3701 / 3721 (16 + 16 AI)	<ul style="list-style-type: none"> <li>• ISTA-TR-AI-STC-370X-118275</li> <li>• Part No. 118275</li> <li>• Drawing No. 36-7463</li> </ul>	<u>Module:</u> • type KFD2-STC4-Ex1, single channel, (AI) <u>Motherboard:</u> • 16 modules (16 channels) • 1 ELCO 56 pin, female system connector • HART 26 pin, male connector <u>Dimensions (wxhxd):</u> • 325x150x150 mm
	<ul style="list-style-type: none"> <li>• ISTA-TR-AI-UT-370X-118276</li> <li>• Part No. 118276</li> <li>• Drawing No. 36-7175</li> </ul>	<u>Module:</u> • type KFD2-UT-Ex1, single channel, (AI) <u>Motherboard:</u> • 16 modules (16 channels) • 1 ELCO 56 pin, female system connector <u>Dimensions (wxhxd):</u> • 325x150x150 mm
3704E / 3720 (32 + 32 AI)	<ul style="list-style-type: none"> <li>• ISTA-TR-AI-STC-370X-118290</li> <li>• Part No. 118290</li> <li>• Drawing No. 36-7468</li> </ul>	<u>Module:</u> • type KFD2-UT-Ex1, single channel, (AI) <u>Motherboard:</u> • 32 modules (32 channels) • 1 ELCO 56 pin, female system connector • 2 HART 26 pin, male connector <u>Dimensions (wxhxd):</u> • 650x150x150 mm
3805E (8 AO)	<ul style="list-style-type: none"> <li>• ISTA-TR-AO-SCD-380X-118277</li> <li>• Part No. 118277</li> <li>• Drawing No. 36-7464</li> </ul>	<u>Module:</u> • type KFD2-SCD-Ex1.LK, single channel, (AO) <u>Motherboard:</u> • 8 modules (8 channels) • 1 ELCO 56 pin, female system connector • 2 HART 26 pin, male connector <u>Dimensions (wxhxd):</u> • 165x150x150 mm

## 2. 3503E / 3505E Application

(16 + 16 channels DI)

	Page
<b>Simplified schematic 3503E / 3505E</b> .....	2- 1
<b>2 x Motherboard ISTA-TR-DI-SH-350X-118289</b> .....	2- 3
<b>Part No.:</b>	118289
<b>Function:</b>	Digital Input
<b>Channels:</b>	16
<b>System cable:</b>	(ELCO connector)
<b>KF- Module:</b>	KFD2-SH-Ex1.T.OP (single channel)
<b>Simplified schematic:</b>	drawing no. 36-9279
<b>Wiring Diagram:</b>	drawing no. 36-7443
<b>2 x Motherboard ISTA-TR-DI-SRLB-350X-122110</b> .....	2- 6
<b>Part No.:</b>	122110
<b>Function:</b>	Digital Input
<b>Channels:</b>	16
<b>System cable:</b>	(ELCO connector)
<b>KF- Module:</b>	KFD2-SR2-Ex1.W.LB (single channel)
<b>Simplified schematic:</b>	drawing no. 36-9279
<b>Wiring Diagram:</b>	drawing no. 36-7417
<b>Simplified schematic 3503E / 3505E</b> .....	2- 9
<b>Motherboard ISTA-TR-DI-SR2-350X-118271</b> .....	2- 11
<b>Part No.:</b>	118271
<b>Function:</b>	Digital Input
<b>Channels:</b>	16 + 16
<b>System cable:</b>	(ELCO connector)
<b>KF- Module:</b>	KFD2-SR2-Ex2.2S (dual channel)
<b>Simplified schematic:</b>	drawing no. 36-9280
<b>Wiring Diagram:</b>	drawing no. 36-7413
<b>Motherboard ISTA-TR-DI-SOT2-350X-118272</b> .....	2- 14
<b>Part No.:</b>	118272
<b>Function:</b>	Digital Input
<b>Channels:</b>	16 + 16
<b>System cable:</b>	(ELCO connector)
<b>KF- Module:</b>	KFD2-SOT2-Ex2 (dual channel)
<b>Simplified schematic:</b>	drawing no. 36-9280
<b>Wiring Diagram:</b>	drawing no. 36-7169

**3503E / 3505E DIGITAL INPUT MODULE (Fail safe)**

**Simplified schematic of a typical 32-point commoned 24 VDC digital input module with self-test (1 of 32 points shown)**

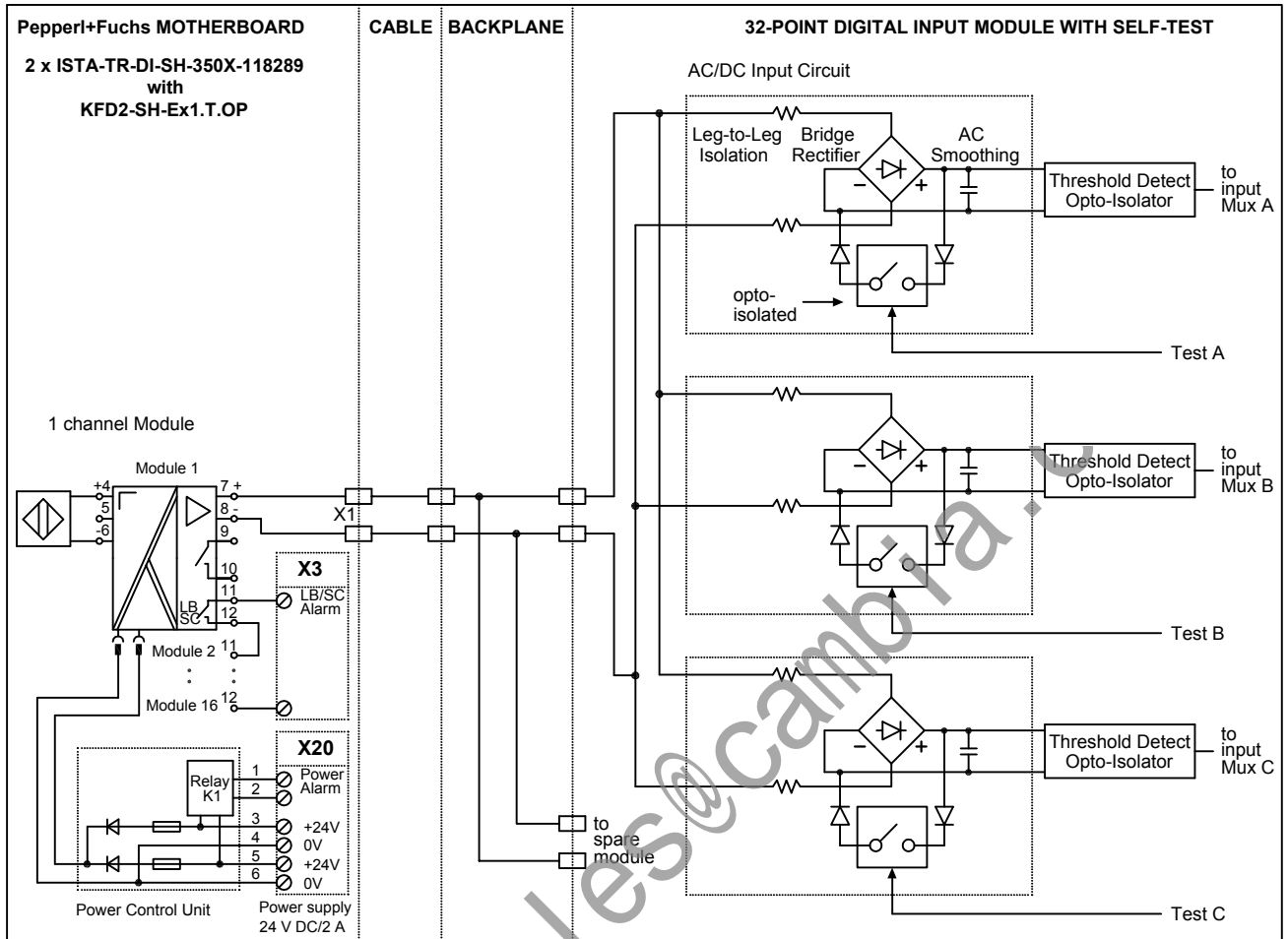

**Pin assignment of connector #A (56 pin ELCO female)**

Pin	AA	KK	LL	z	DD	EE	p	u	v	h	k	l	e	a
Signal	IN1+		IN1-	IN2+		IN2-	IN3+		IN3-	IN4+		IN4-	IN5+	
Pin	b	W	R	S	L	E	F	M	A	B	BB	NN	MM	CC
Signal	IN5-	IN6+		IN6-	IN7+		IN7-	IN8+		IN8-	IN9+		IN9-	IN10+
Pin	JJ	HH	t	y	x	j	n	m	f	d	c	Z	V	U
Signal		IN10-	IN11+		IN11-	IN12+		IN12-	IN13+		IN13-	IN14+		IN14-
Pin	P	K	J	N	D	C	T	H	w	FF	r	s	X	Y
Signal	IN15+		IN15-	IN16+		IN16-	CGND	CGND	CGND	CGND	**	**	**	**

**Pin assignment of connector #B (56 pin ELCO female)**

Pin	AA	KK	LL	z	DD	EE	p	u	v	h	k	l	e	a
Signal	IN17+		IN17-	IN18+		IN18-	IN19+		IN19-	IN20+		IN20-	IN21+	
Pin	b	W	R	S	L	E	F	M	A	B	BB	NN	MM	CC
Signal	IN21-	IN22+		IN22-	IN23+		IN23-	IN24+		IN24-	IN25+		IN25-	IN26+
Pin	JJ	HH	t	y	x	j	n	m	f	d	c	Z	V	U
Signal		IN26-	IN27+		IN27-	IN28+		IN28-	IN29+		IN29-	IN30+		IN30-
Pin	P	K	J	N	D	C	T	H	w	FF	r	s	X	Y
Signal	IN31+		IN31-	IN32+		IN32-	CGND	CGND	CGND	CGND	**	**	**	**

\*\* not used

CGND is the chassis ground

02.03.99	AJ	AJ	--	
Date	S	TZ	Off. in ch.	contr. Norm
Dept.: PA-VP	Nr. <b>36-9279</b>			
Up date: 19.03.04	Replaces: XXXXX / 36-XXXX		Sheet 1	
Scale:		- : - of 2		



**PEPPERL+FUCHS**  
Mannheim-Schönau

**D-TR-3503E / 3505E**

copyright according to DIN34  
unauthorized distribution and reproduction prohibited

**3503E / 3505E DIGITAL INPUT MODULE (Non-Fail safe)**

**Simplified schematic of a typical 32-point commoned 24 VDC digital input module with self-test (1 of 32 points shown)**

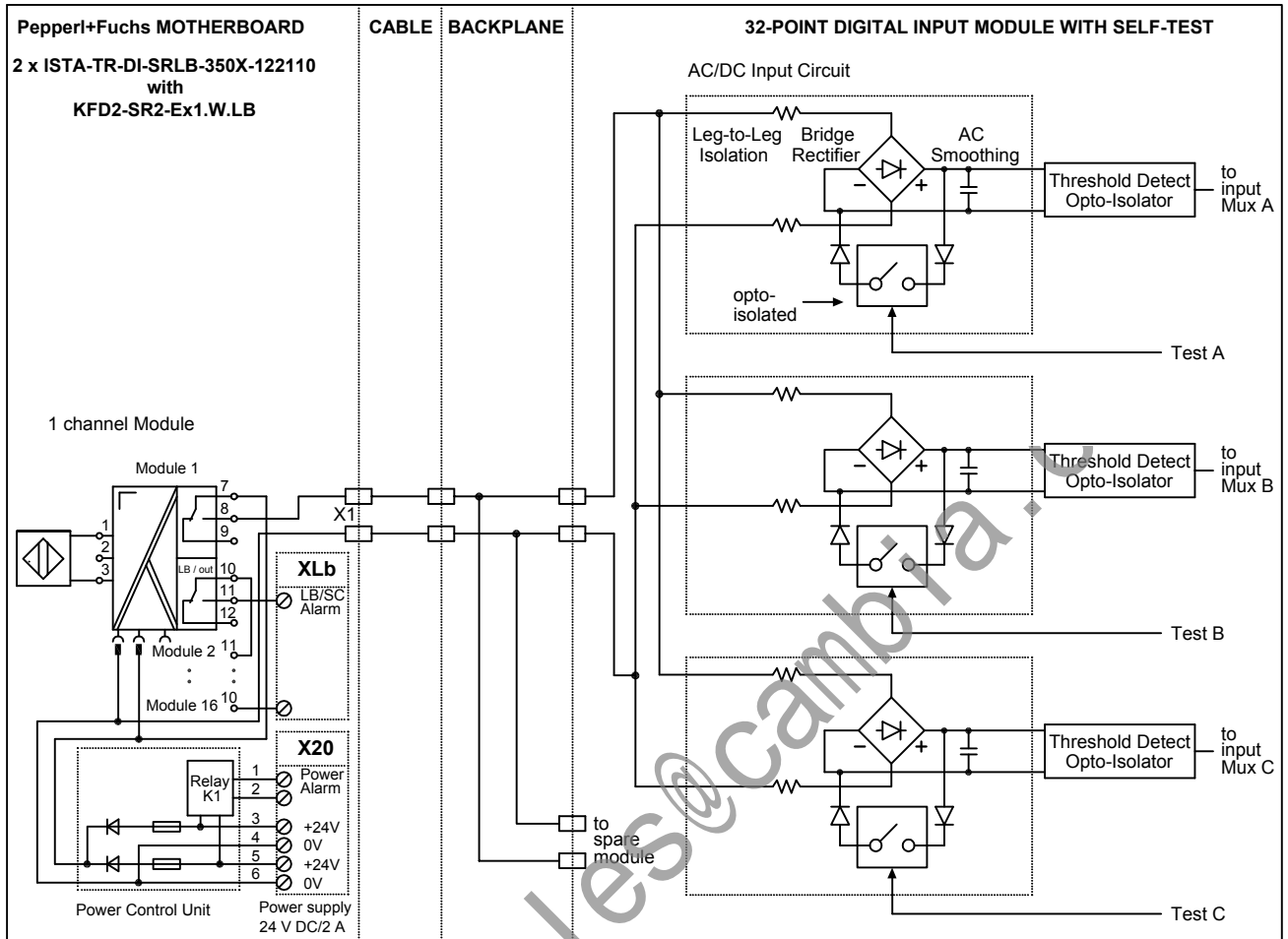

**Pin assignment of connector #A (56 pin ELCO female)**

Pin	AA	KK	LL	z	DD	EE	p	u	v	h	k	l	e	a
Signal	IN1+		IN1-	IN2+		IN2-	IN3+		IN3-	IN4+		IN4-	IN5+	
Pin	b	W	R	S	L	E	F	M	A	B	BB	NN	MM	CC
Signal	IN5-	IN6+		IN6-	IN7+		IN7-	IN8+		IN8-	IN9+		IN9-	IN10+
Pin	JJ	HH	t	y	x	j	n	m	f	d	c	Z	V	U
Signal		IN10-	IN11+		IN11-	IN12+		IN12-	IN13+		IN13-	IN14+		IN14-
Pin	P	K	J	N	D	C	T	H	w	FF	r	s	X	Y
Signal	IN15+		IN15-	IN16+		IN16-	CGND	CGND	CGND	CGND	**	**	**	**

**Pin assignment of connector #B (56 pin ELCO female)**

Pin	AA	KK	LL	z	DD	EE	p	u	v	h	k	l	e	a
Signal	IN17+		IN17-	IN18+		IN18-	IN19+		IN19-	IN20+		IN20-	IN21+	
Pin	b	W	R	S	L	E	F	M	A	B	BB	NN	MM	CC
Signal	IN21-	IN22+		IN22-	IN23+		IN23-	IN24+		IN24-	IN25+		IN25-	IN26+
Pin	JJ	HH	t	y	x	j	n	m	f	d	c	Z	V	U
Signal		IN26-	IN27+		IN27-	IN28+		IN28-	IN29+		IN29-	IN30+		IN30-
Pin	P	K	J	N	D	C	T	H	w	FF	r	s	X	Y
Signal	IN31+		IN31-	IN32+		IN32-	CGND	CGND	CGND	CGND	**	**	**	**

\*\* not used

CGND is the chassis ground

02.03.99	AJ	AJ	--	
Date	S	TZ	Off. in ch.	contr. techn.
Dept.: PA-VP	Nr. <b>36-9279</b>			
Up date: 19.03.04	AvB/Bro	Replaces: XXXXX / 36-XXXX	Sheet 2	
Scale:		- : - of 2		



**PEPPERL+FUCHS**  
Mannheim-Schönau

**D-TR-3503E / 3505E**

copyright according to DIN34  
unauthorized distribution and reproduction prohibited

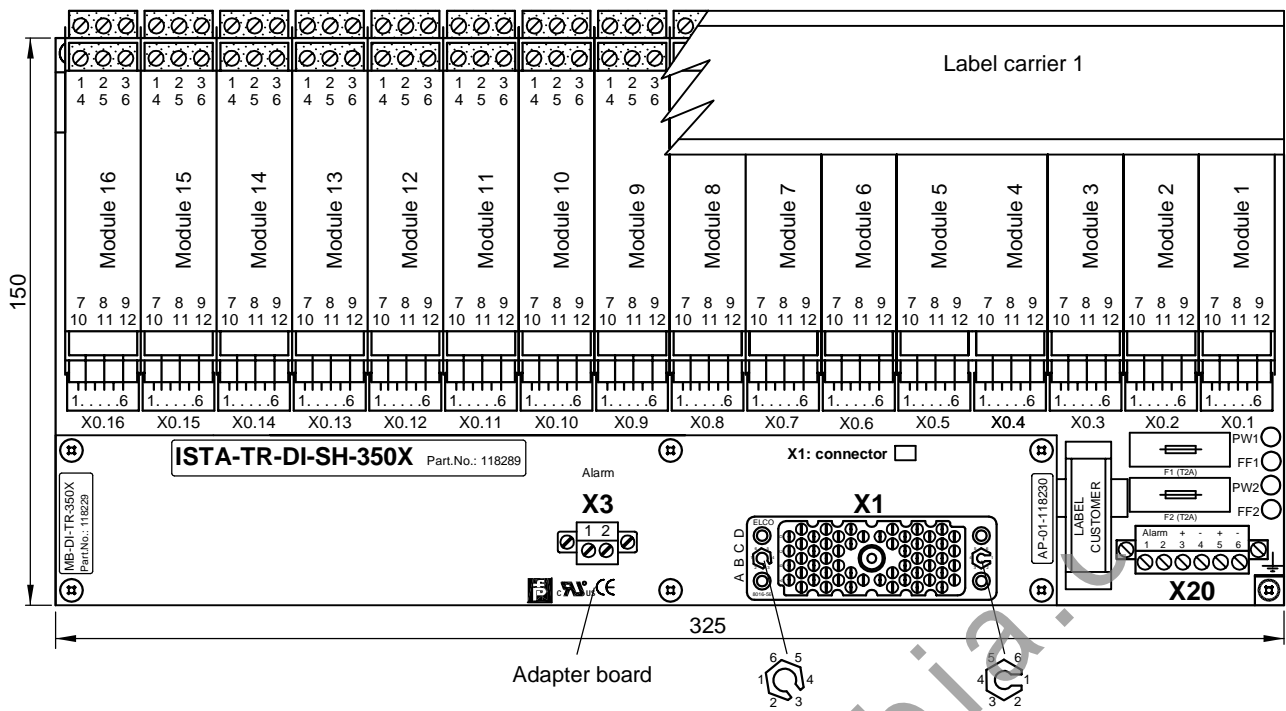

**APPLICATION:**

**TRICONEX I/O card 3503E / 3505E (2 x ISTA-TR-DI-SH-350X-118289)**  
 32 points, non commoned, diff., DC coupled

Motherboard 2: connected with connector #B  
 Module 1 ... 16, channels 17 ... 32

Motherboard 1: connected with connector #A  
 Module 1 ... 16, channels 1 ... 16

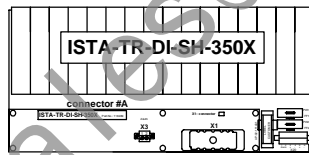
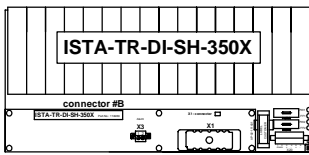

Name	Note
X1	56 pin female system connector ELCO (small key: 1, large key: 3)
X3	2 pin screw terminal
X0.1 .... 16	6 pin male terminals for cable tree FSY....
X20.3 .... 6	Power supply screw terminals
X20.1, X20.2	Alarm screw terminal
F1, F2	Fuse
PW1, PW2, FF1, FF2	LEDs for power and power failure

**Ordering information: ISTA-TR-DI-SH-350X-118289**

Basic components:	Description
<b>16 pieces:</b> KFD2-SH-Ex1.T.OP (DI/FS)	KF-Module type (function)
<b>1 piece:</b> MB-DI-TR-350X-118229	Motherboard without modules
<b>composed by:</b>	
1 piece: MB-16U5L-103681	Motherboard without modules, adapter board, FSY cable tree and Label carrier
1 piece: AP-01-118230	Adapter board
1 piece: KFD0-LC1-16M-99144	Label carrier 1
16 pieces: FSY-K023L540-118266	Cable tree connection KF-Module-Motherboard

copyright according to DIN34  
 unauthorized distribution and reproduction prohibited

	<b>PEPPERL+FUCHS</b> Mannheim-Schönau	Motherboard unit Digital Input (Fail Safe) 16 channels - LB/SC monitoring <b>ISTA-TR-DI-SH-350X</b>	03.04.02	KT	Sb	Sb	
			Date	S TZ	Off. in ch.	contr. techn.	contr. Norm
			Dept.: PA-VP	<b>Nr. 36-7443A</b>			
Up date: 30.03.05	vB/Bro	Replaces: xxxxx / 36-xxxx	Sheet 1				
MB-16U5L	Scale: 1 : 2 (1 : 8)	of 3					

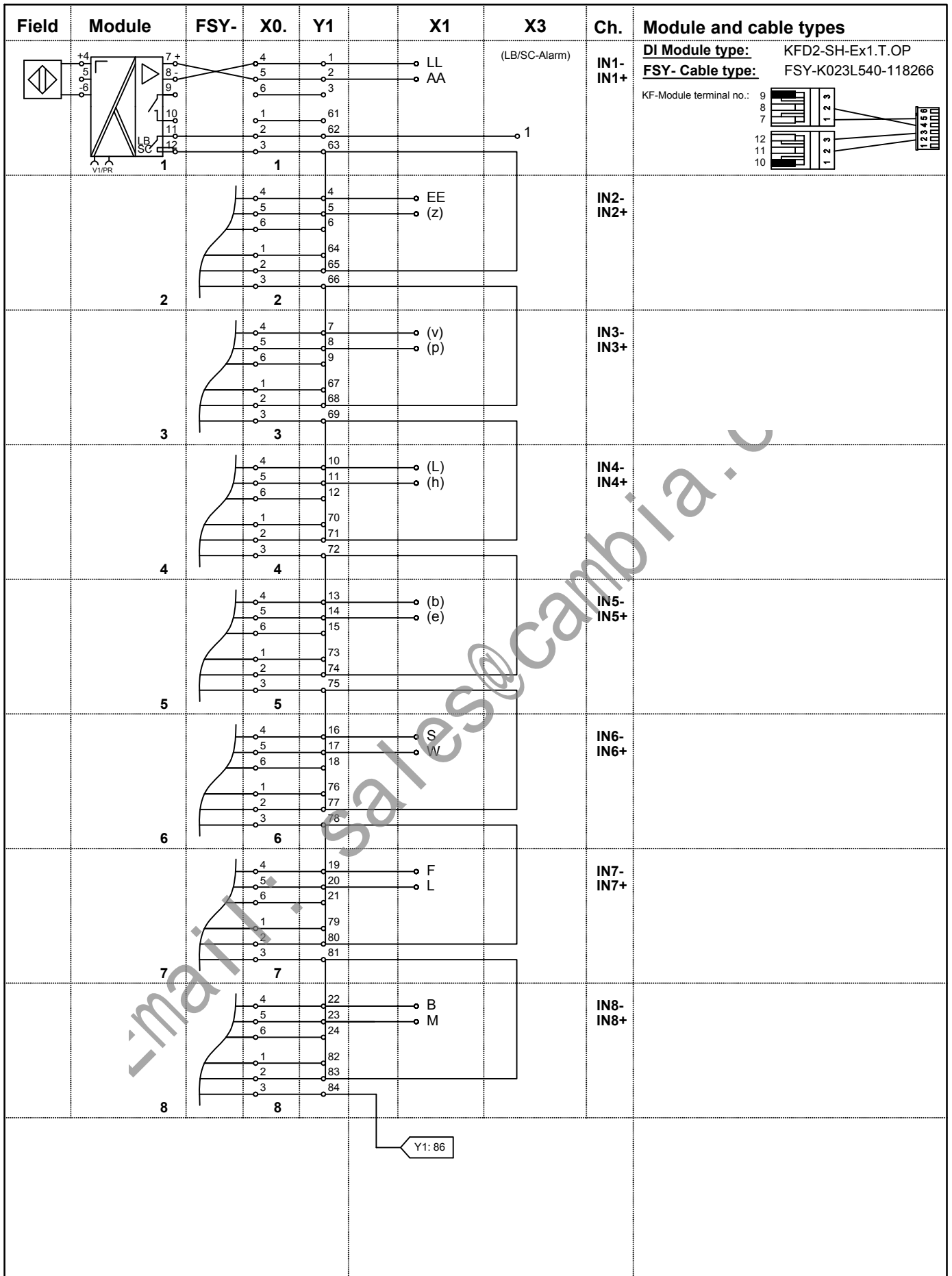

copyright according to DIN34 unauthorized distribution and reproduction prohibited

	<b>PEPPERL+FUCHS</b> Mannheim-Schönau	Motherboard unit Digital Input (Fail Safe) 16 channels - LB/SC monitoring <b>ISTA-TR-DI-SH-350X</b>	03.04.02		KT	Sb	Sb/vB		
			Date	S	TZ	Off. in ch.	contr. techn.	contr. Norm	
			Dept.:	PA-VP	<b>Nr. 36-7443A</b>		Replaces:		Sheet 2
			Up date:	vB/Bro 18.03.04	xxxx / 36-xxxx				
	MB-16U5L		Scale:	- : -		of 3			

Field	Module	FSY-	X0.	Y1	X1	X3	Ch.
	9	Y1: 84	4, 5, 6, 1, 2, 3	25, 26, 27, 85, 86, 87	MM, BB	(LB/SC-Alarm)	IN9- IN9+
	10		4, 5, 6, 1, 2, 3	28, 29, 30, 88, 89, 90	HH, CC		IN10- IN10+
	11		4, 5, 6, 1, 2, 3	31, 32, 33, 91, 92, 93	(x), (t)		IN11- IN11+
	12		4, 5, 6, 1, 2, 3	34, 35, 36, 94, 95, 96	(m), (j)		IN12- IN12+
	13		4, 5, 6, 1, 2, 3	37, 38, 39, 97, 98, 99	(c), (f)		IN13- IN13+
	14		4, 5, 6, 1, 2, 3	40, 41, 42, 100, 101, 102	U, Z		IN14- IN14+
	15		4, 5, 6, 1, 2, 3	43, 44, 45, 103, 104, 105	J, P		IN15- IN15+
	16		4, 5, 6, 1, 2, 3	46, 47, 48, 106, 107, 108	C, N		IN16- IN16+
			(+ 24VDC) X20: 3,5	49 ... 51			
			(0V) X20: 4,6	52 ... 54			
			Ground metal mounting plate	55			
			V1	56			
			V2	57			
			LB/SC	58			
			PF1	59			
			PF2	60			

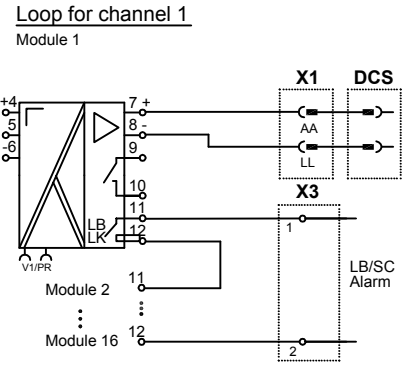

copyright according to DIN34  
unauthorized distribution and reproduction prohibited

	Motherboard unit Digital Input (Fail Safe) 16 channels - LB/SC monitoring <b>ISTA-TR-DI-SH-350X</b>		03.04.02	KT	Sb	Sb/vB	
	Date	S TZ	Off. in ch.	contr. techn.	contr. Norm		
	Dept.: PA-VP	vB/Bro	<b>Nr. 36-7443A</b>		Replaces:		Sheet 3
	Up date: 18.03.04		xxxx / 36-xxxx				
	MB-16U5L		Scale: - : -				of 3



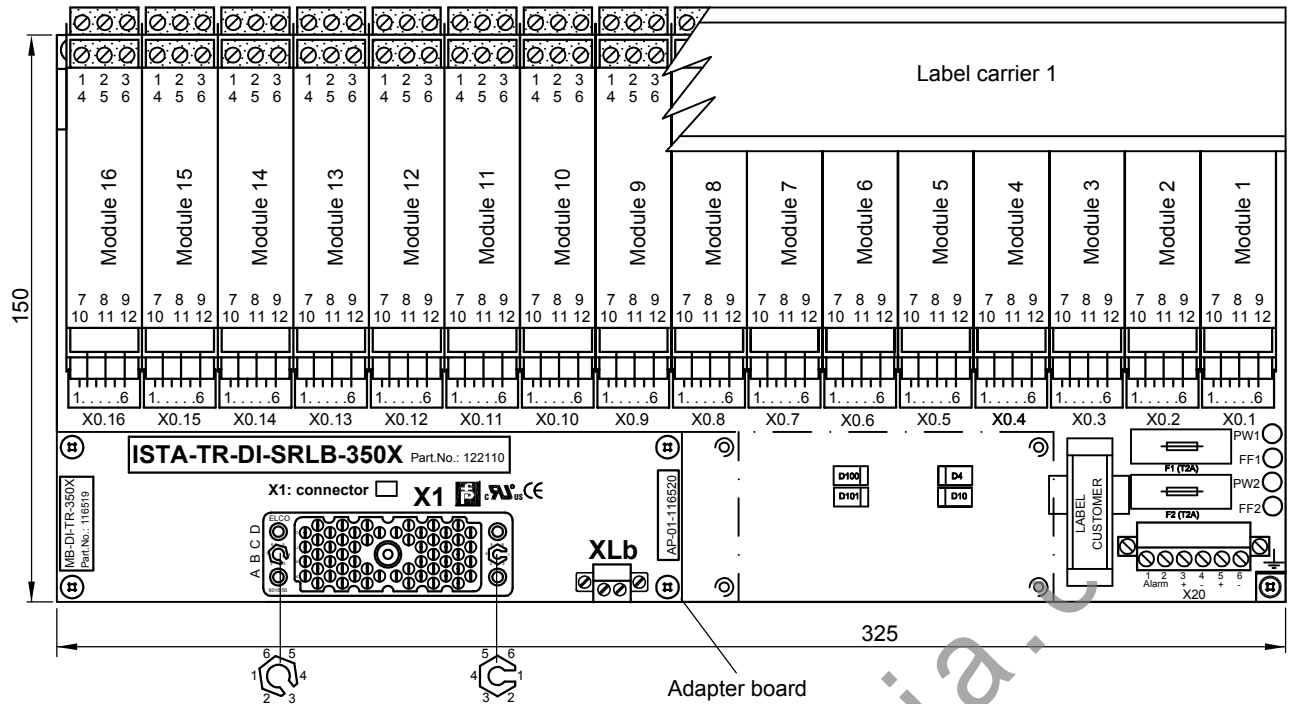

**APPLICATION:**

**TRICONEX I/O card 3503E / 3505E: will be required 2 x ISTA-TR-DI-SRLB-350X-122110**  
32 points, commoned in groups of 8

Motherboard: connected with connector #B  
Module 1 ... 16, channels 17 ... 32

connected with connector #A  
Module 1 ... 16, channels 1 ... 16

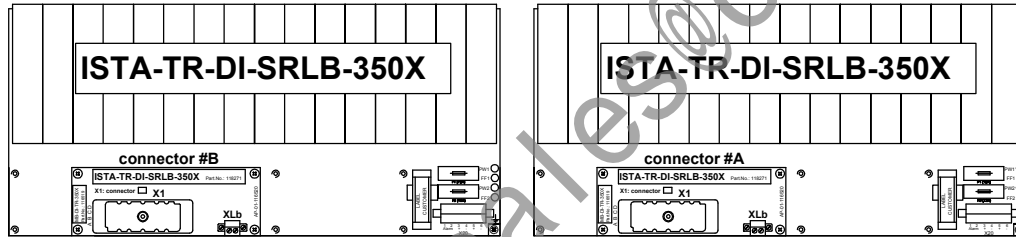

Name	Note
X1	56 pin female system connector ELCO (small key: 1, large key: 3)
XLb	2 pin screw terminals
X0.1 .... 16	6 pin male terminals for cable tree FSY....
X20.3 .... 6	Power supply screw terminals
X20.1, X20.2	Alarm screw terminal
F1, F2	Fuse
PW1, PW2, FF1, FF2	LEDs for power and power failure

**Ordering information: ISTA-TR-DI-SRLB-350X-122110**

Basic components:	Description
<b>16 pieces:</b> KFD2-SR2-Ex1.W.LB (DI)	KF-Module type (function)
<b>1 piece:</b> MB-DI-TR-350X-116519	Motherboard without modules
<b>composed by:</b>	
1 piece: MB-16U5L-103681	Motherboard without modules, adapter board, FSY cable tree and Label carrier
1 piece: AP-01-116520	Adapter board
1 piece: KFD0-LC1-16M-99144	Label carrier 1
16 pieces: FSY-K120L450-Y98836	Cable tree connection KF-Module-Motherboard

08.11.01	KT	Sb	Sb	
Date	S TZ	Off. in ch.	contr. techn.	contr. Norm
Dept.: PA-VP	Nr. <b>36-7417</b>			
Up date: 18.03.04	vB/Bro	Replaces: Y95447 / 36-7021	Sheet 1	
MB-16U5L	Scale: 1 : 2 (1 : 5)	of 3		



**PEPPERL+FUCHS**  
Mannheim-Schönau

Motherboard unit  
Digital Input  
16 channels, LB/SC monitoring  
**ISTA-TR-DI-SRLB-350X**



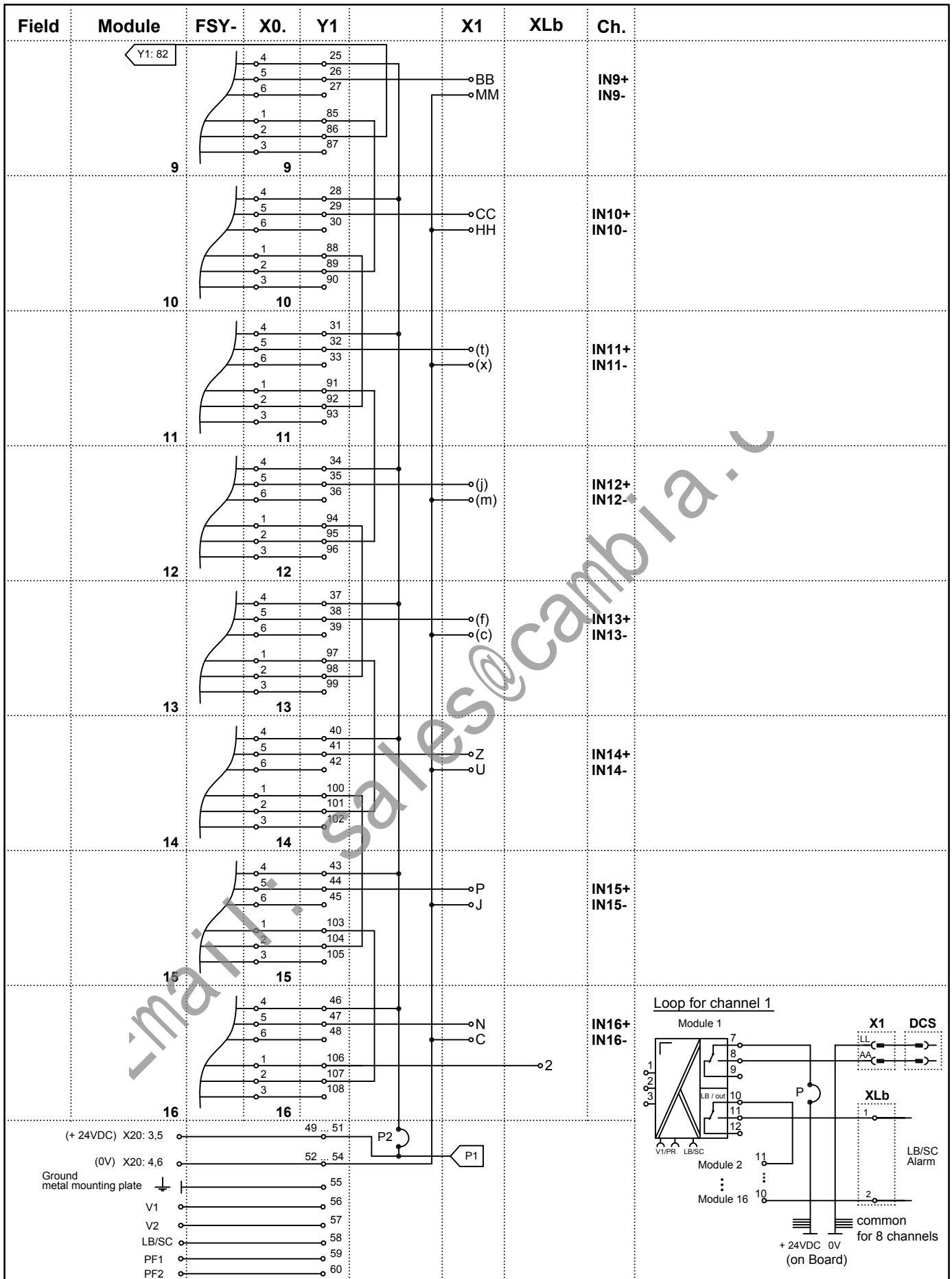

copyright according to DIN34 unauthorized distribution and reproduction prohibited

P2 = link (0 Ohm resistors)  
Note: Letters in brackets are small letters

08.11.01		KT	vB	vB/Sb	
Date	S	TZ	Off. in ch.	contr. techn.	contr. Norm
Dept.: PA-VP		Nr. <b>36-7417</b>			
Up date: 18.03.04		Replaces: Y95447 / 36-7021		Sheet 3	
MB-16U5L		Scale:		of 3	



**PEPPERL+FUCHS**  
Mannheim-Schönau

Motherboard unit  
Digital Input  
16 channels, LB/SC monitoring  
**ISTA-TR-DI-SRLB-350X**

**3503E / 3505E DIGITAL INPUT MODULE**

**Simplified schematic of a typical 32-point commoned 24 VDC digital input module with self-test (1 of 32 points shown)**

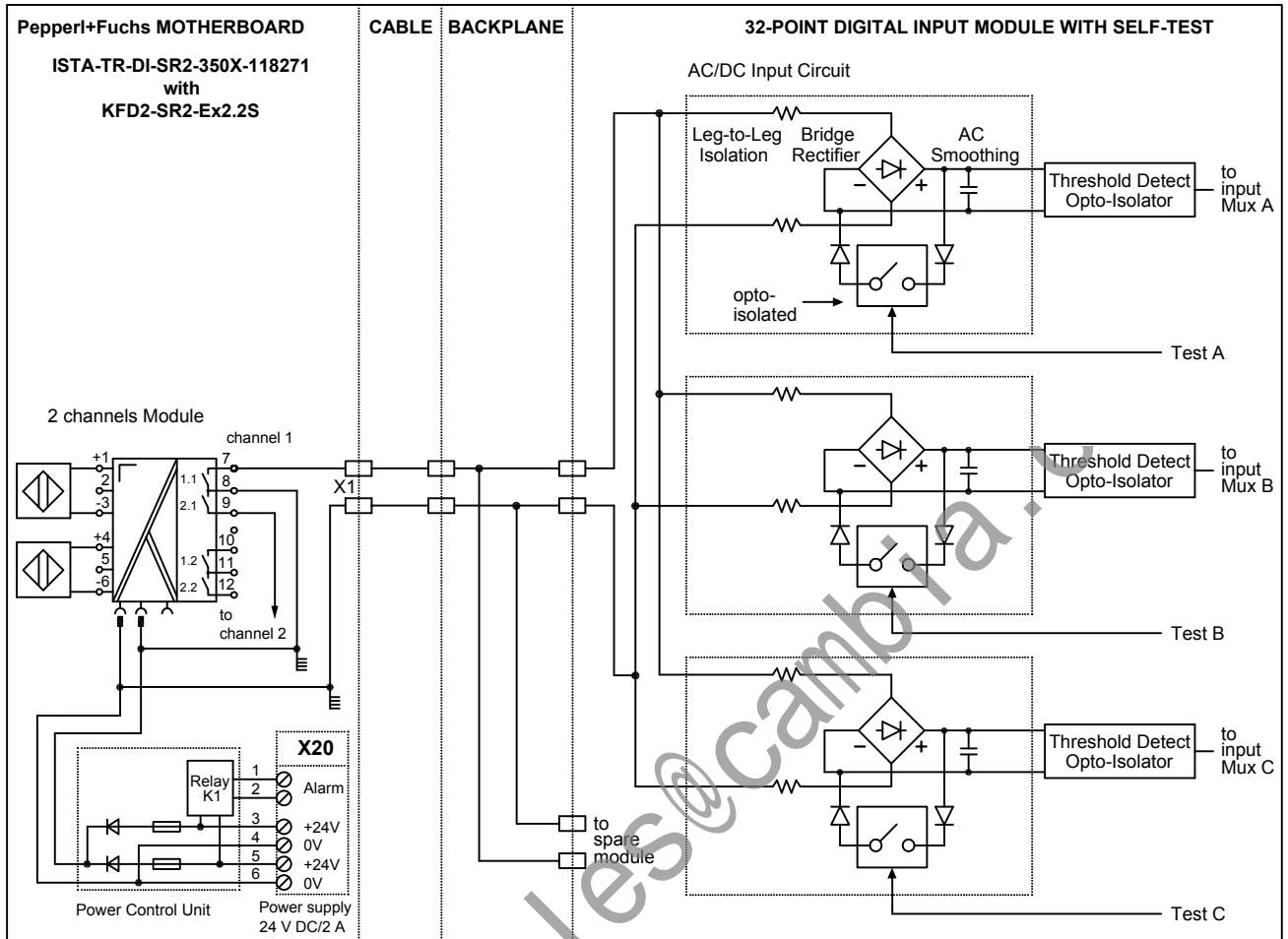

**Pin assignment of connector #1 (56 pin ELCO female)**

Pin	AA	KK	LL	z	DD	EE	p	u	v	h	k	l	e	a
Signal	IN1+		IN1-	IN2+		IN2-	IN3+		IN3-	IN4+		IN4-	IN5+	
Pin	b	W	R	S	L	E	F	M	A	B	BB	NN	MM	CC
Signal	IN5-	IN6+		IN6-	IN7+		IN7-	IN8+		IN8-	IN9+		IN9-	IN10+
Pin	JJ	HH	t	y	x	j	n	m	f	d	c	Z	V	U
Signal		IN10-	IN11+		IN11-	IN12+		IN12-	IN13+		IN13-	IN14+		IN14-
Pin	P	K	J	N	D	C	T	H	w	FF	r	s	X	Y
Signal	IN15+		IN15-	IN16+		IN16-	CGND	CGND	CGND	CGND	**	**	**	**

**Pin assignment of connector #2 (56 pin ELCO female)**

Pin	AA	KK	LL	z	DD	EE	p	u	v	h	k	l	e	a
Signal	IN17+		IN17-	IN18+		IN18-	IN19+		IN19-	IN20+		IN20-	IN21+	
Pin	b	W	R	S	L	E	F	M	A	B	BB	NN	MM	CC
Signal	IN21-	IN22+		IN22-	IN23+		IN23-	IN24+		IN24-	IN25+		IN25-	IN26+
Pin	JJ	HH	t	y	x	j	n	m	f	d	c	Z	V	U
Signal		IN26-	IN27+		IN27-	IN28+		IN28-	IN29+		IN29-	IN30+		IN30-
Pin	P	K	J	N	D	C	T	H	w	FF	r	s	X	Y
Signal	IN31+		IN31-	IN32+		IN32-	CGND	CGND	CGND	CGND	**	**	**	**

\*\* not used

CGND is the chassis ground

02.03.99	AJ	AJ	--	
Date	S	TZ	Off. in ch.	contr. techn.
Dept.: PA-VP	Nr. <b>36-9280</b>			
Up date: 19.03.04	Replaces: XXXXX / 36-XXXX			Sheet 1
Scale: - : -			of 2	



**PEPPERL+FUCHS**  
Mannheim-Schönau

**D-TR-3503E / 3505E**

copyright according to DIN34  
unauthorized distribution and reproduction prohibited

**3503E / 3505E DIGITAL INPUT MODULE**

**Simplified schematic of a typical 32-point commoned 24 VDC digital input module with self-test (1 of 32 points shown)**

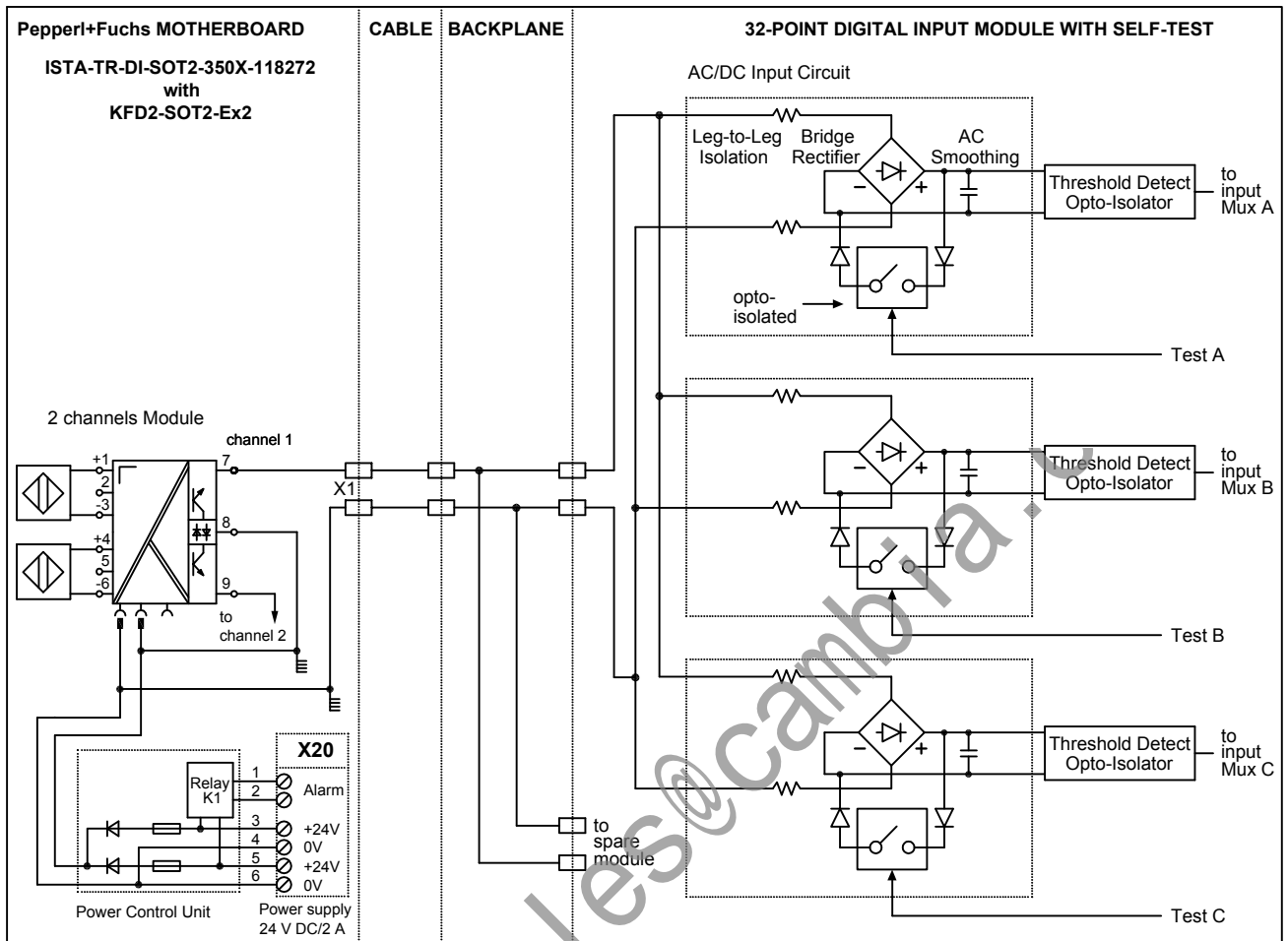

**Pin assignment of connector #1 (56 pin ELCO female)**

Pin	AA	KK	LL	z	DD	EE	p	u	v	h	k	l	e	a
Signal	IN1+		IN1-	IN2+		IN2-	IN3+		IN3-	IN4+		IN4-	IN5+	
Pin	b	W	R	S	L	E	F	M	A	B	BB	NN	MM	CC
Signal	IN5-	IN6+		IN6-	IN7+		IN7-	IN8+		IN8-	IN9+		IN9-	IN10+
Pin	JJ	HH	t	y	x	j	n	m	f	d	c	Z	V	U
Signal		IN10-	IN11+		IN11-	IN12+		IN12-	IN13+		IN13-	IN14+		IN14-
Pin	P	K	J	N	D	C	T	H	w	FF	r	s	X	Y
Signal	IN15+		IN15-	IN16+		IN16-	CGND	CGND	CGND	CGND	**	**	**	**

**Pin assignment of connector #2 (56 pin ELCO female)**

Pin	AA	KK	LL	z	DD	EE	p	u	v	h	k	l	e	a
Signal	IN17+		IN17-	IN18+		IN18-	IN19+		IN19-	IN20+		IN20-	IN21+	
Pin	b	W	R	S	L	E	F	M	A	B	BB	NN	MM	CC
Signal	IN21-	IN22+		IN22-	IN23+		IN23-	IN24+		IN24-	IN25+		IN25-	IN26+
Pin	JJ	HH	t	y	x	j	n	m	f	d	c	Z	V	U
Signal		IN26-	IN27+		IN27-	IN28+		IN28-	IN29+		IN29-	IN30+		IN30-
Pin	P	K	J	N	D	C	T	H	w	FF	r	s	X	Y
Signal	IN31+		IN31-	IN32+		IN32-	CGND	CGND	CGND	CGND	**	**	**	**

** not used	CGND is the chassis ground					02.03.99	AJ	AJ	--		
						Date	S	TZ	Off. in ch.	contr. techn.	contr. Norm
 <b>PEPPERL+FUCHS</b> Mannheim-Schönau	<b>D-TR-3503E / 3505E</b>					Dept.: PA-VP	<b>Nr. 36-9280</b>				
						Up date: 19.03.04	vB/Bro	Replaces: XXXXX / 36-XXXX		Sheet 2	
							Scale:	- : -	of 2		

copyright according to DIN34 unauthorized distribution and reproduction prohibited

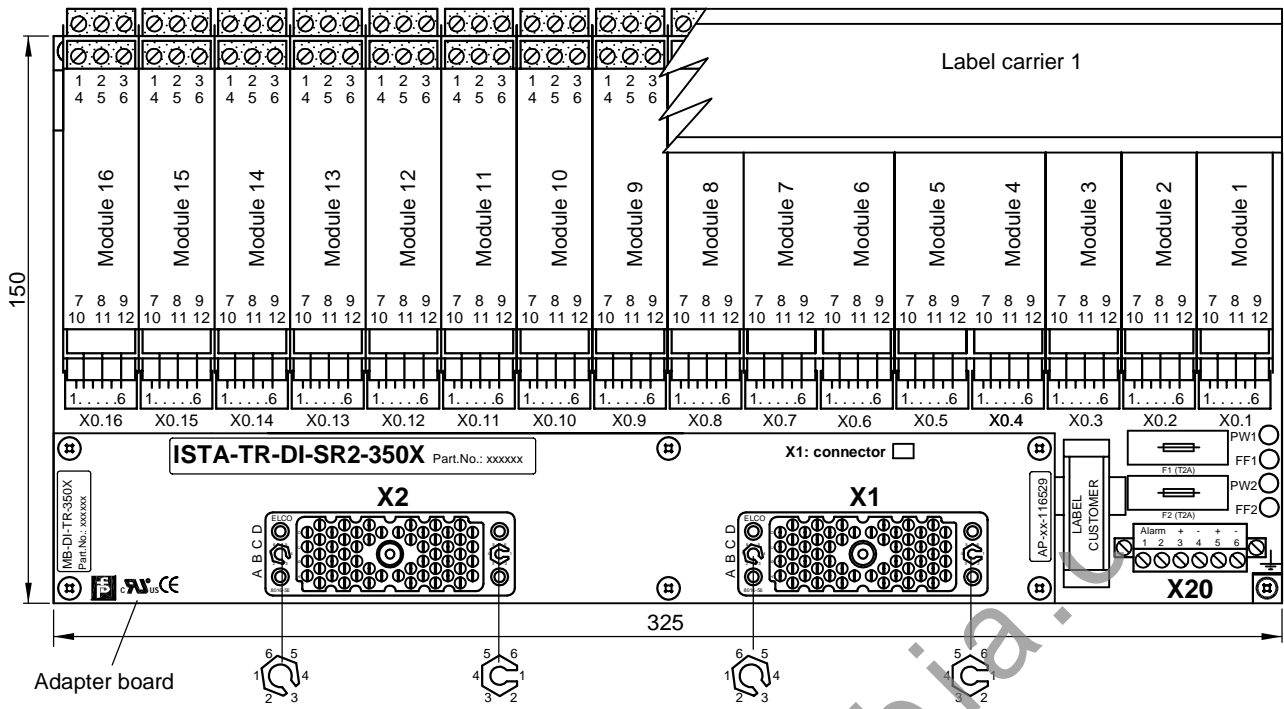

**APPLICATION:**

**TRICONEX I/O card 3503E / 3505E:**  
16 + 16 points, commoned in groups of 8

Motherboard: connected with connector #1  
Module 1 ... 8, channels 1 ... 16

connected with connector #2  
Module 9 ... 16, channels 17 ... 32

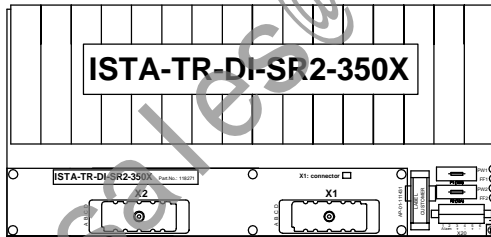

Name	Note
X1	56 pin female system connector ELCO (small key: 1, large key: 3)
X2	56 pin female system connector ELCO (small key: 1, large key: 3)
X0.1 .... 16	6 pin male terminals for cable tree FSY....
X20.3 .... 6	Power supply screw terminals
X20.1, X20.2	Alarm screw terminal
F1, F2	Fuse
PW1, PW2, FF1, FF2	LEDs for power and power failure

Ordering information:	ISTA-TR-DI-SR2-350X-118271	ISTA-TR-DI-SR2-350X-192285	Description
<b>Basic components:</b>			
<b>16 pieces:</b>	<b>KFD2-SR2-Ex2.2S (DI)</b>	<b>KFD2-SR2-2.2S (DI)</b>	KF-Module type (function)
<b>1 piece:</b>	<b>MB-DI-TR-350X-116528</b>	<b>MB-DI-TR-350X-192284</b>	Motherboard without modules
<b>composed by:</b>			
1 piece:	MB-16U5L-103681	MB-16U5L-103681	Basis Motherboard (*)
1 piece:	AP-01-116529	AP-05-116529	Adapter board
1 piece:	KFD0-LC1-16M-99144	KFD0-LC1-16M-99144	Label carrier 1
16 pieces:	FSY-L456-98837	FSY-L456-98837	FSY-Cable tree

(\*) Basis Motherboard without modules, adapter board and FSY cable tree (conection between Motherboard and Modules)

copyright according to DIN34  
unauthorized distribution and reproduction prohibited

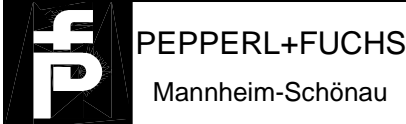
	Motherboard unit Digital Input 16 + 16 channels <b>ISTA-TR-DI-SR2-350X</b>	18.03.02	KT	vB	vB/Sb	
		Date	S TZ	Off. in ch.	contr. techn.	contr. Norm
		Dept.: PA-VP	<b>Nr. 36-7413B</b>			
		vB/Bro	Replaces:			
		Up date: 03.04.06	xxxxx / 36-xxxx			Sheet 1
		MB-16U5L	Scale: 1 : 2, 1:5	of 3		

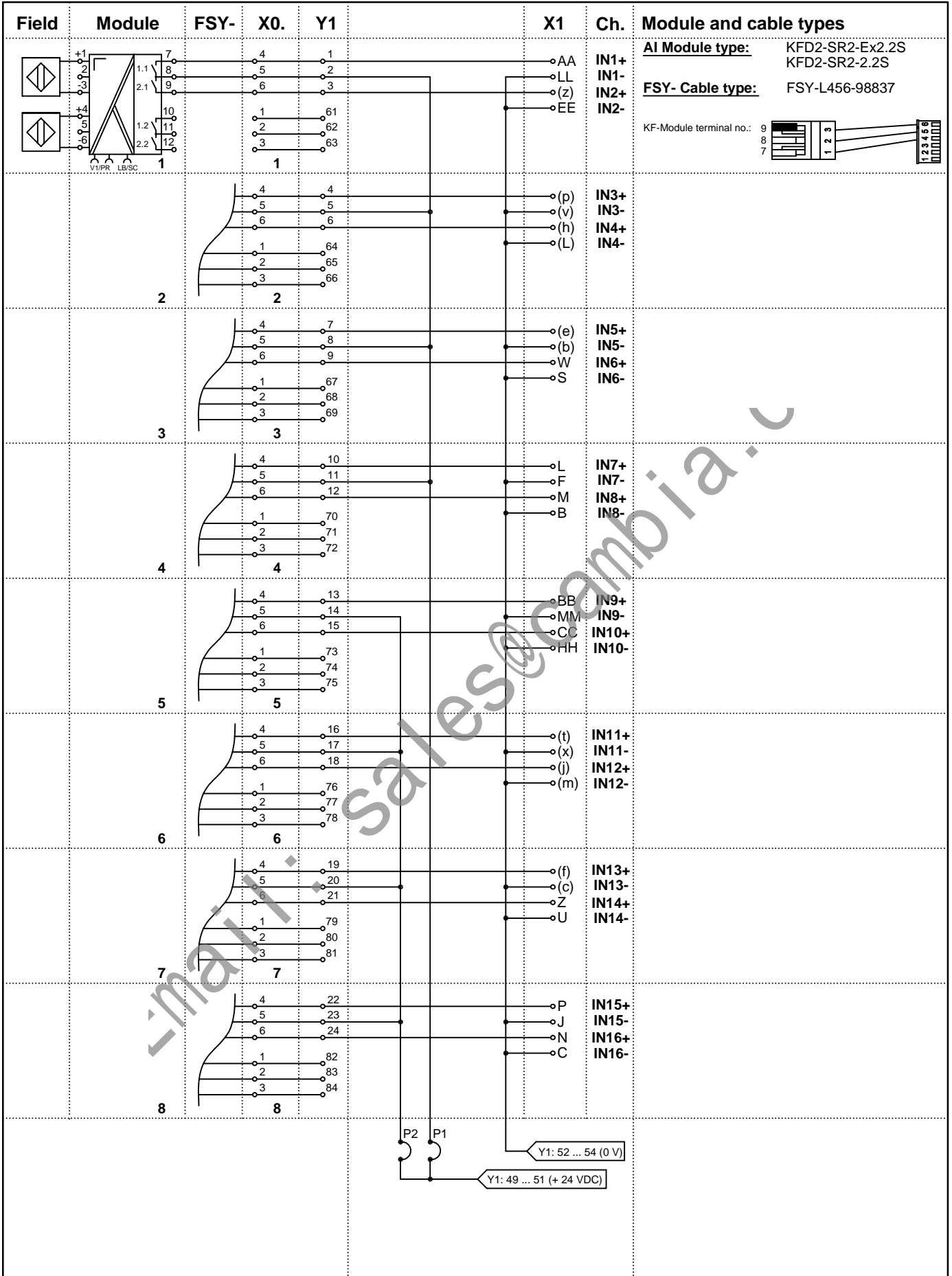

P1, P2 = link (resistor 0 Ohm)

Note: Letters in brackets are small letters

18.03.02		KT	vB	vB/Sb	
Date	S	TZ	Off. in ch.	contr. techn.	contr. Norm
Dept.: PA-VP	Nr. <b>36-7413B</b>				
Up date: 03.04.06	Replaces: vB/Bro xxxxxx / 36-xxxx		Sheet 2		
MB-16U5L	Scale:		of 3		

**PEPPERL+FUCHS**  
Mannheim-Schönau

Motherboard unit  
Digital Input  
16 + 16 channels  
**ISTA-TR-DI-SR2-350X**

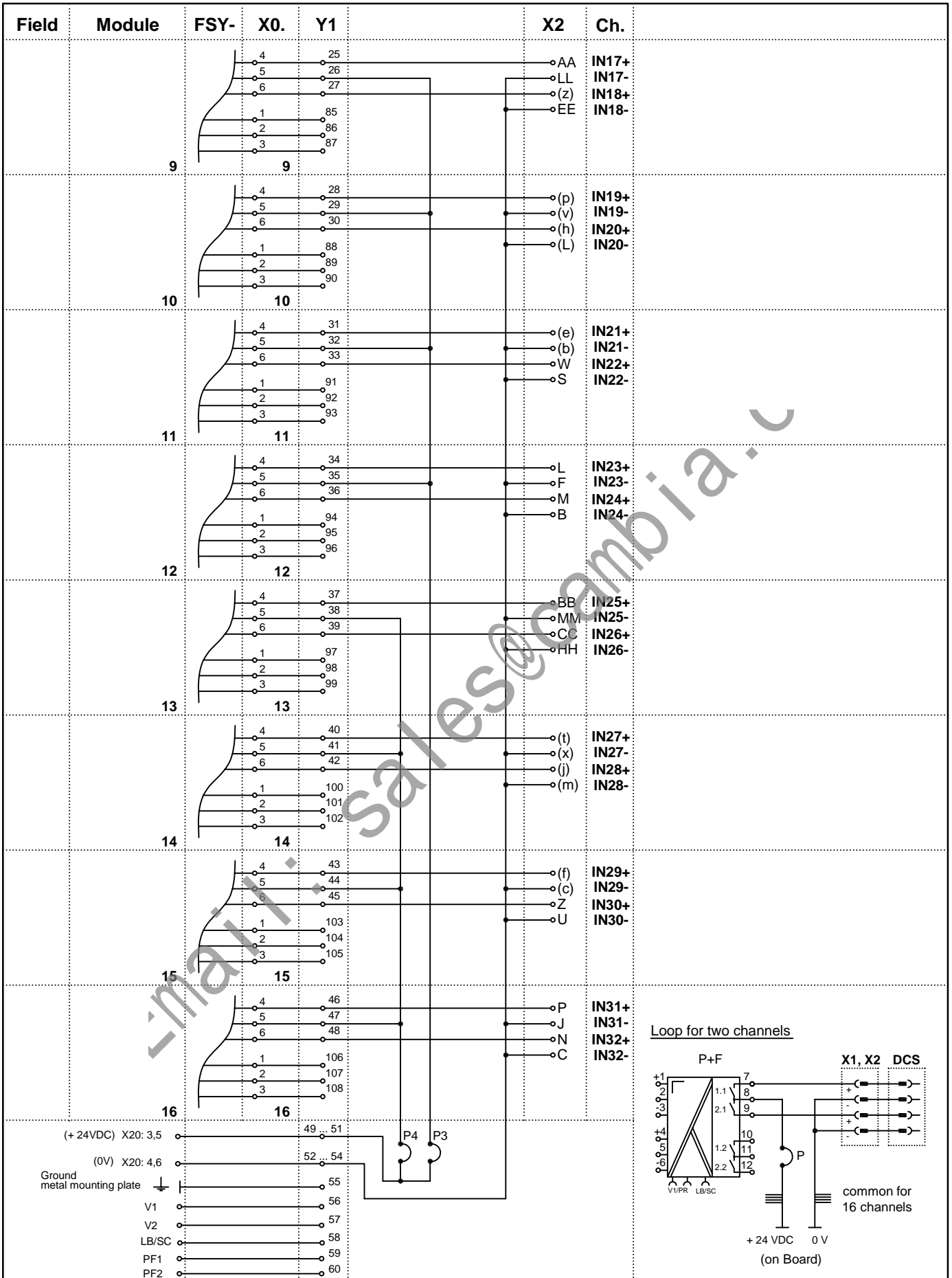

P3, P4 = link (resistor 0 Ohm)

Note: Letters in brackets are small letters

18.03.02		KT	vB	vB/Sb	
Date	S	TZ	Off. in ch.	contr. techn.	contr. Norm
Dept.: PA-VP	vB/Brö		Nr. <b>36-7413B</b>		
Up date: 03.04.06	Replaces: xxxxxx / 36-xxxx		Sheet 3		
MB-16U5L	Scale:		of 3		

**PF**  
**PEPPERL+FUCHS**  
Mannheim-Schönau

Motherboard unit  
Digital Input  
16 + 16 channels  
**ISTA-TR-DI-SR2-350X**



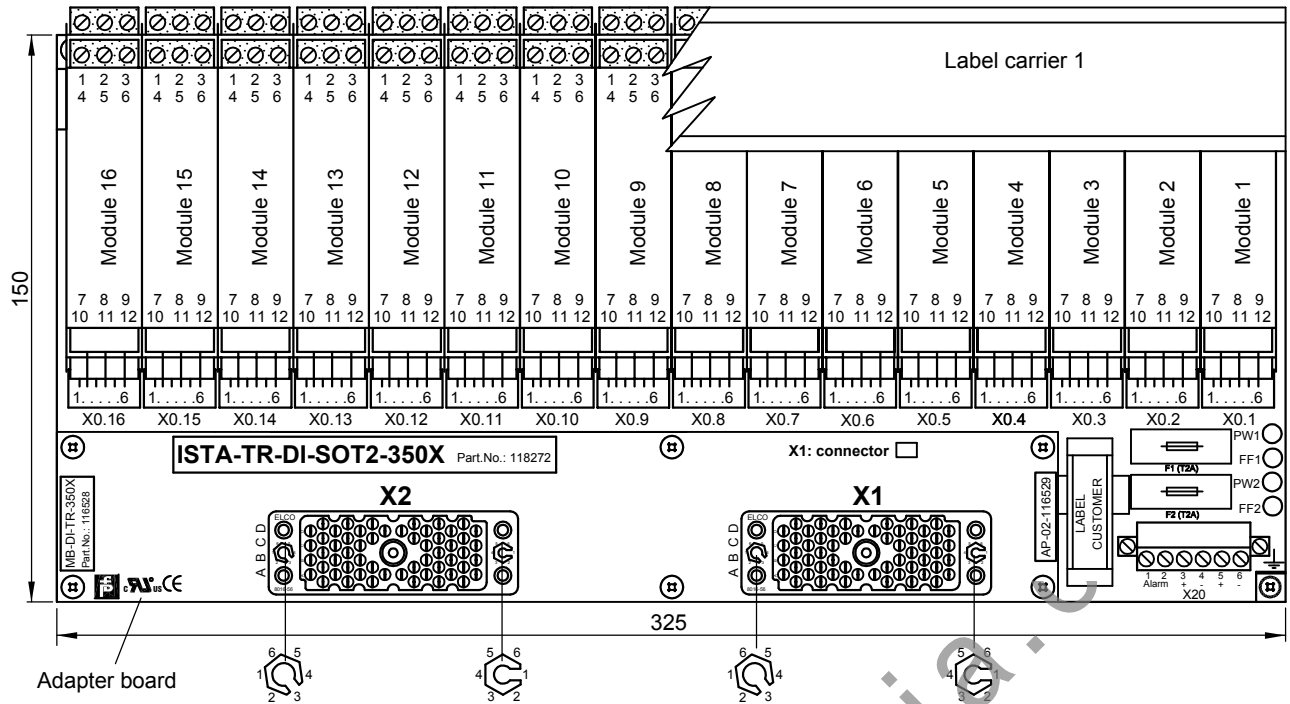

**APPLICATION:**

**TRICONEX I/O card 3503E / 3505E:**  
16 + 16 points, commoned in groups of 8

Motherboard: connected with connector #1  
Module 1 ... 8, channels 1 ... 16

connected with connector #2  
Module 9 ... 16, channels 1 ... 16

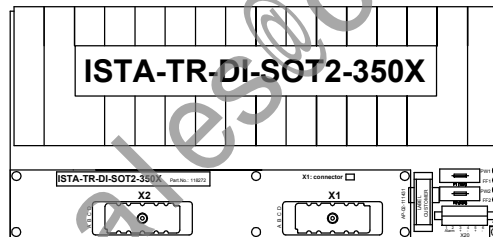

Name	Note
X1	56 pin female system connector ELCO (small key: 1, large key: 3)
X2	56 pin female system connector ELCO (small key: 1, large key: 3)
X0.1 .... 16	6 pin male terminals for cable tree FSY....
X20.3 .... 6	Power supply screw terminals
X20.1, X20.2	Alarm screw terminal
F1, F2	Fuse
PW1, PW2, FF1, FF2	LEDs for power and power failure

**Ordering information: ISTA-TR-DI-SOT2-350X-118272**

Basic components:	Description
<b>16 pieces:</b> KFD2-SOT2-Ex2 (DI)	KF-Module type (function)
<b>1 piece:</b> MB-DI-TR-350X-116528	Motherboard without modules
<b>composed by:</b>	
1 piece: MB-16U5L-103681	Motherboard without modules, adapter board, FSY cable tree and Label carrier
1 piece: AP-02-116529	Adapter board
1 piece: KFD0-LC1-16M-99144	Label carrier 1
16 pieces: FSY-L456-98837	Cable tree connection KF-Module-Motherboard

18.03.02	KT	vB	vB/Sb	
Date	S TZ	Off. in ch.	contr. techn.	contr. Norm



**PEPPERL+FUCHS**  
Mannheim-Schönau

Motherboard unit  
Digital Input  
16 + 16 channels  
**ISTA-TR-DI-SOT2-350X**

Dept.: PA-VP	<b>Nr. 36-7169</b>
Up date: 18.03.04	Replaces: xxxxxx / 36-xxxx
MB-16U5L	Scale: 1 : 2, 1:5
	Sheet 1 of 3

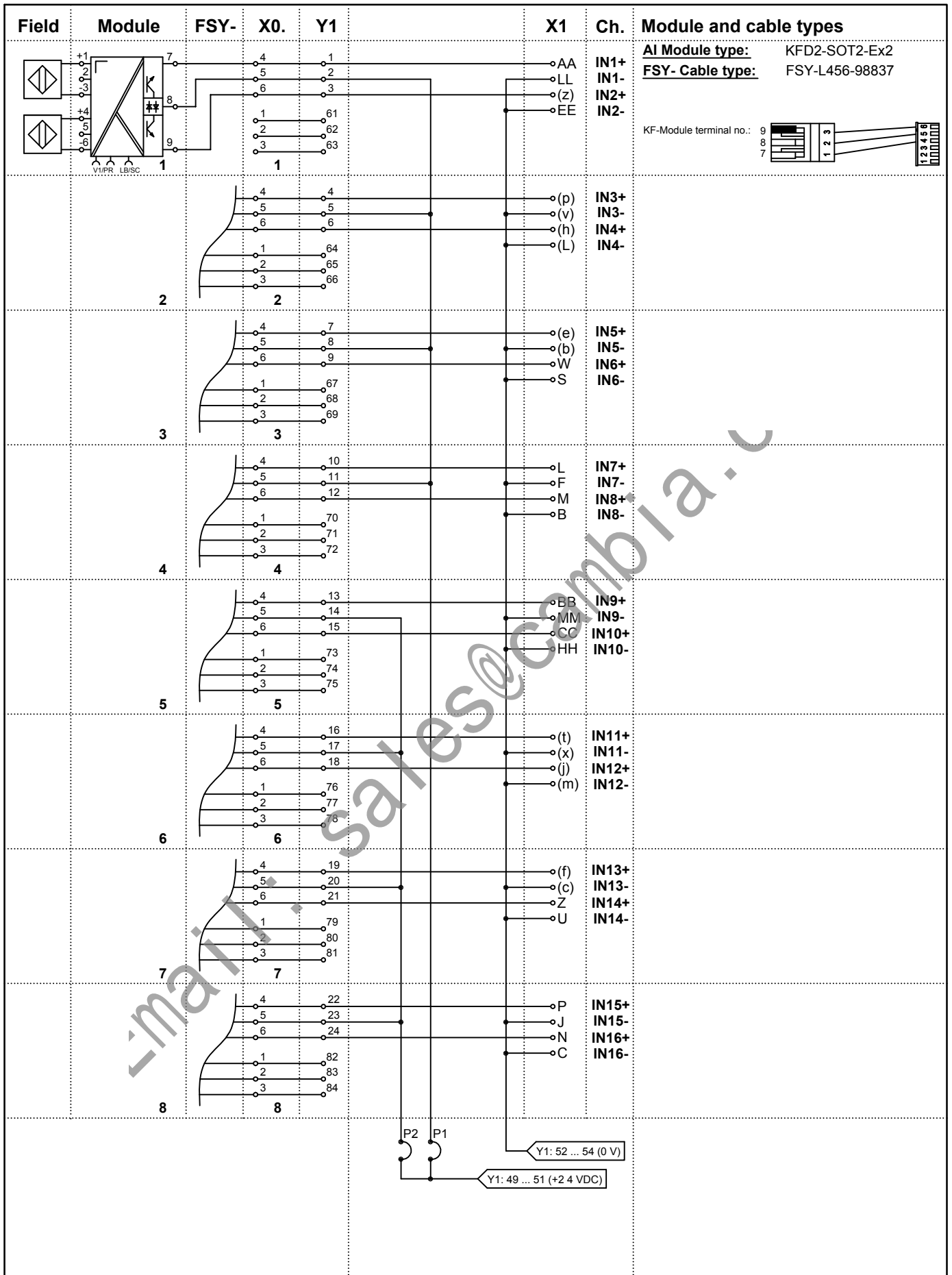

P1, P2 = link (resistor 0 Ohm)

Note: Letters in brackets are small letters

18.03.02		KT	vB	vB/Sb	
Date	S	TZ	Off. in ch.	contr. techn.	contr. Norm
Dept.: PA-VP			Nr. <b>36-7169</b>		
Up date: 18.03.04		Replaces: xxxxx / 36-xxxx		Sheet 2	
MB-16U5L			Scale:		of 3



**PEPPERL+FUCHS**  
Mannheim-Schönau

Motherboard unit  
Digital Input  
16 + 16 channels  
**ISTA-TR-DI-SOT2-350X**

copyright according to DIN34  
 unauthorized distribution and reproduction prohibited

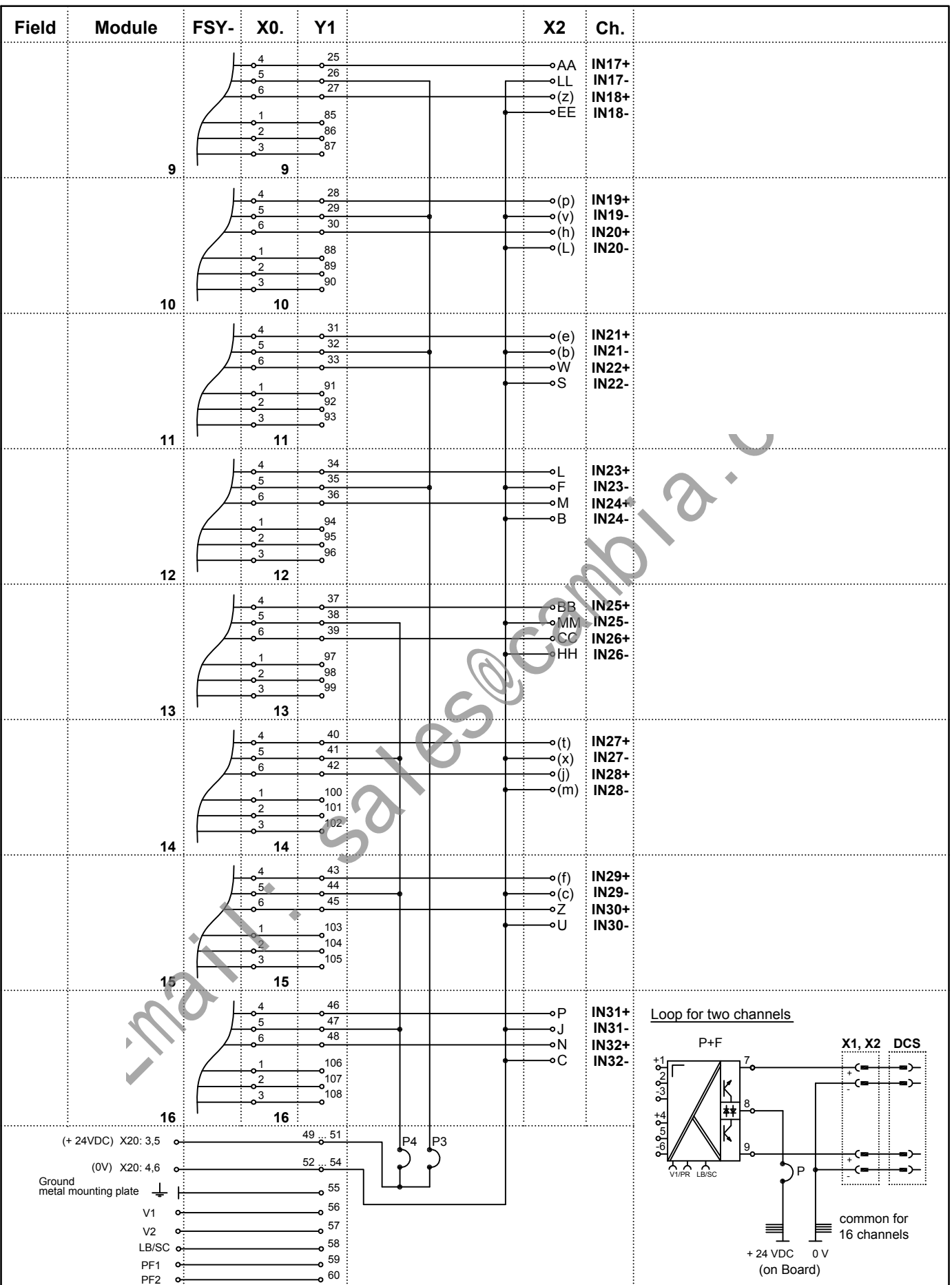

P3, P4 = link (resistor 0 Ohm)

Note: Letters in brackets are small letters

18.03.02		KT	vB	vB/Sb	
Date	S	TZ	Off. in ch.	contr. techn.	contr. Norm
Dept.: PA-VP		Nr. <b>36-7169</b>			
Up date: 18.03.04		Replaces: xxxxx / 36-xxxx		Sheet 3	
MB-16U5L		Scale:		of 3	



**PEPPERL+FUCHS**  
 Mannheim-Schönau

Motherboard unit  
 Digital Input  
 16 + 16 channels  
**ISTA-TR-DI-SOT2-350X**

### 3. 3504E / 3564 Application

(32 + 32 channels DI)

	Page
<b>Simplified schematic 3504E</b> .....	3- 1
<b>Simplified schematic 3564</b> .....	3- 3
<b>2 x Motherboard ISTA-TR-DI-SR2-35XX-118278</b> .....	3- 4
<b>Part No.:</b>	118278
<b>Function:</b>	Digital Input
<b>Channels:</b>	32
<b>System cable:</b>	(ELCO connector)
<b>KF- Module:</b>	KFD2-SR2-Ex2.2S (dual channel)
<b>Simplified schematic:</b>	drawing no. 36-9281 drawing no. 36-9282
<b>Wiring Diagram:</b>	drawing no. 36-7361
<b>2 x Motherboard ISTA-TR-DI-SOT2-35XX-118279</b> .....	3- 7
<b>Part No.:</b>	118279
<b>Function:</b>	Digital Input
<b>Channels:</b>	32
<b>System cable:</b>	(ELCO connector)
<b>KF- Module:</b>	KFD2-SOT2-Ex2 (dual channel)
<b>Simplified schematic:</b>	drawing no. 36-9281 drawing no. 36-9282
<b>Wiring Diagram:</b>	drawing no. 36-7188

**3504E DIGITAL INPUT MODULE**

**Simplified schematic of a typical 64-point commoned 24 VDC digital input module  
(1 of 64 points shown)**

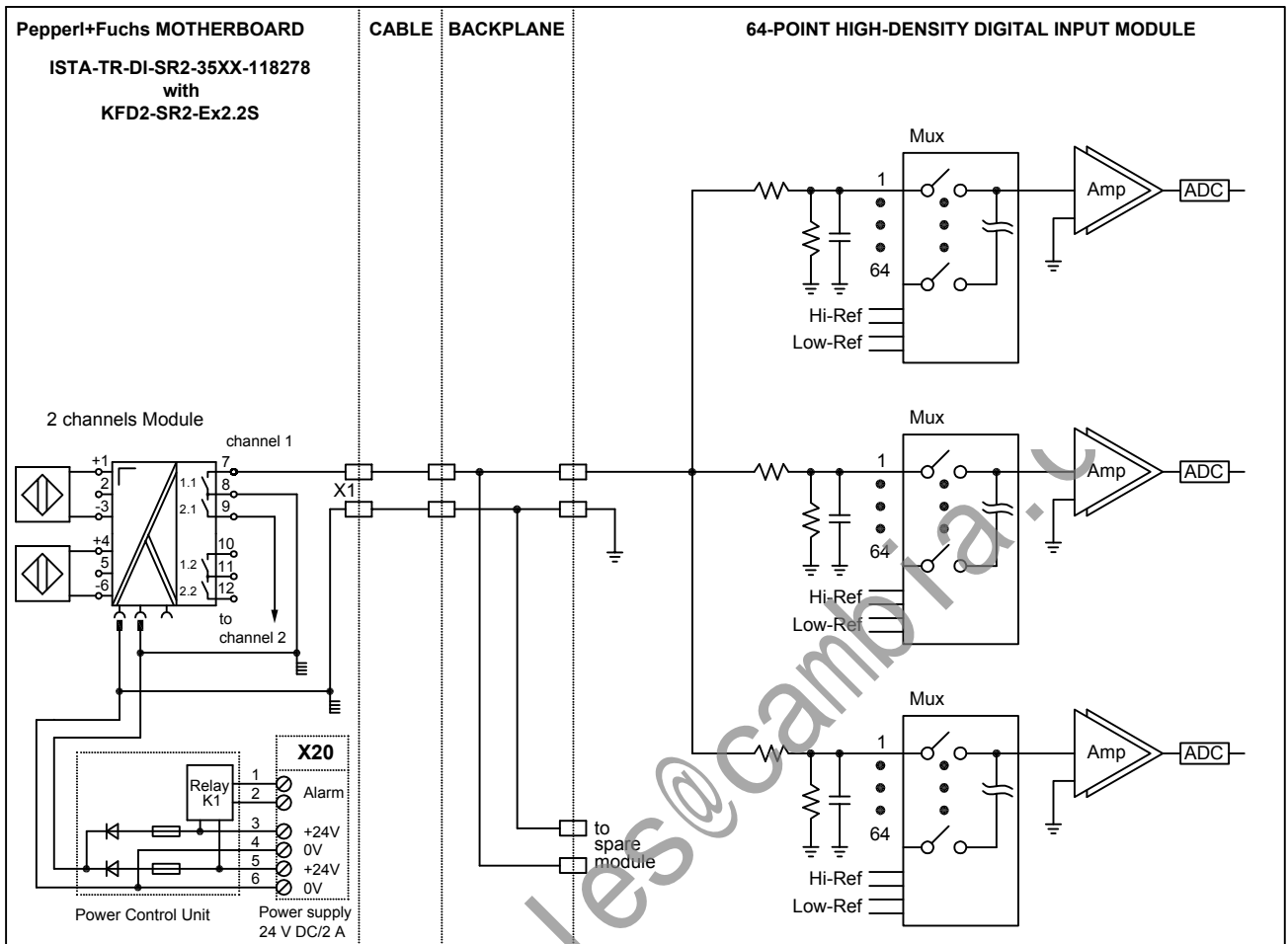

**Pin assignment of connector #A (56 pin ELCO female)**

Pin	AA	KK	LL	z	DD	EE	p	u	v	h	k	l	e	a
Signal	IN1	*	IN2	IN3	RTN	IN4	IN5	*	IN6	IN7	RTN	IN8	IN9	*
Pin	b	W	R	S	L	E	F	M	A	B	BB	NN	MM	CC
Signal	IN10	IN11	RTN	IN12	IN13	RTN	IN14	IN15	RTN	IN16	IN17	RTN	IN18	IN19
Pin	JJ	HH	t	y	x	j	n	m	f	d	c	Z	V	U
Signal	RTN	IN20	IN21	RTN	IN22	IN23	RTN	IN24	IN25	RTN	IN26	IN27	RTN	IN28
Pin	P	K	J	N	D	C	T	H	w	FF	r	s	X	Y
Signal	IN29	RTN	IN30	IN31	RTN	IN32	CGND	CGND	CGND	CGND	**	**	**	**

**Pin assignment of connector #B (56 pin ELCO female)**

Pin	AA	KK	LL	z	DD	EE	p	u	v	h	k	l	e	a
Signal	IN33	RTN	IN34	IN35	RTN	IN36	IN37	RTN	IN38	IN39	RTN	IN40	IN41	RTN
Pin	b	W	R	S	L	E	F	M	A	B	BB	NN	MM	CC
Signal	IN42	IN43	RTN	IN44	IN45	RTN	IN46	IN47	RTN	IN48	IN49	RTN	IN50	IN51
Pin	JJ	HH	t	y	x	j	n	m	f	d	c	Z	V	U
Signal	RTN	IN52	IN53	RTN	IN54	IN55	RTN	IN56	IN57	RTN	IN58	IN59	RTN	IN60
Pin	P	K	J	N	D	C	T	H	w	FF	r	s	X	Y
Signal	IN61	RTN	IN62	IN63	RTN	IN64	CGND	CGND	CGND	CGND	**	**	**	**

\* Reserved for internal use. Do not connect for any purpose.  
\*\* not used  
CGND is the chassis ground

02.03.99		AJ	AJ	--	
Date	S	TZ	Off. in ch.	contr. techn.	contr. Norm



**D-TR-3504E**

Dept.: PA-VP	<b>Nr. 36-9281</b>
vB/Bro	Replaces: XXXXX / 36-XXXX
Up date: 19.03.04	Sheet 1
Scale: - : -	of 2

copyright according to DIN34  
unauthorized distribution and reproduction prohibited

**3504E DIGITAL INPUT MODULE**

**Simplified schematic of a typical 64-point commoned 24 VDC digital input module  
(1 of 64 points shown)**

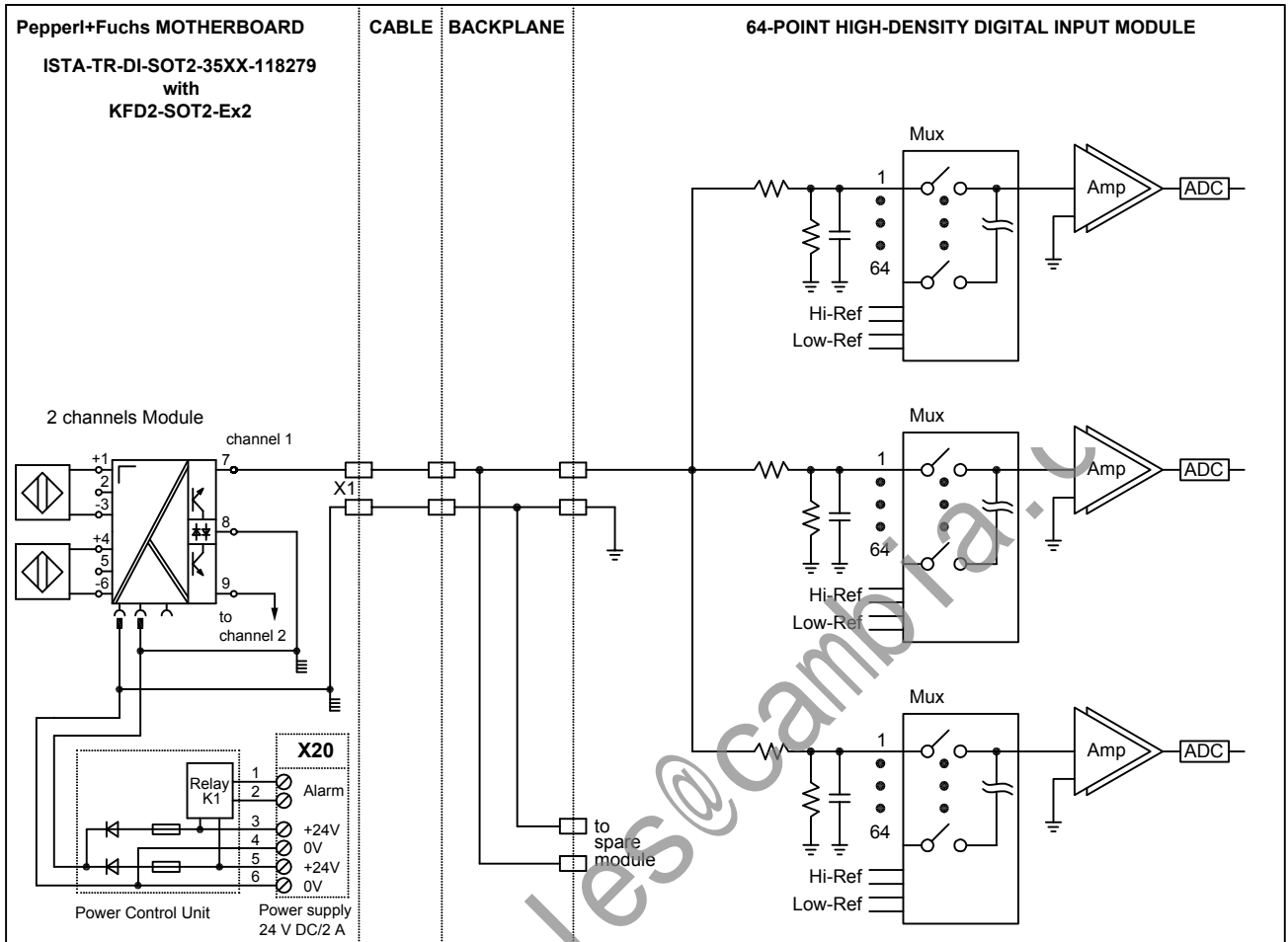

**Pin assignment of connector #A (56 pin ELCO female)**

Pin	AA	KK	LL	z	DD	EE	p	u	v	h	k	l	e	a
Signal	IN1	*	IN2	IN3	RTN	IN4	IN5	*	IN6	IN7	RTN	IN8	IN9	*
Pin	b	W	R	S	L	E	F	M	A	B	BB	NN	MM	CC
Signal	IN10	IN11	RTN	IN12	IN13	RTN	IN14	IN15	RTN	IN16	IN17	RTN	IN18	IN19
Pin	JJ	HH	t	y	x	j	n	m	f	d	c	Z	V	U
Signal	RTN	IN20	IN21	RTN	IN22	IN23	RTN	IN24	IN25	RTN	IN26	IN27	RTN	IN28
Pin	P	K	J	N	D	C	T	H	w	FF	r	s	X	Y
Signal	IN29	RTN	IN30	IN31	RTN	IN32	CGND	CGND	CGND	CGND	**	**	**	**

**Pin assignment of connector #B (56 pin ELCO female)**

Pin	AA	KK	LL	z	DD	EE	p	u	v	h	k	l	e	a
Signal	IN33	RTN	IN34	IN35	RTN	IN36	IN37	RTN	IN38	IN39	RTN	IN40	IN41	RTN
Pin	b	W	R	S	L	E	F	M	A	B	BB	NN	MM	CC
Signal	IN42	IN43	RTN	IN44	IN45	RTN	IN46	IN47	RTN	IN48	IN49	RTN	IN50	IN51
Pin	JJ	HH	t	y	x	j	n	m	f	d	c	Z	V	U
Signal	RTN	IN52	IN53	RTN	IN54	IN55	RTN	IN56	IN57	RTN	IN58	IN59	RTN	IN60
Pin	P	K	J	N	D	C	T	H	w	FF	r	s	X	Y
Signal	IN61	RTN	IN62	IN63	RTN	IN64	CGND	CGND	CGND	CGND	**	**	**	**

\* Reserved for internal use. Do not connect for any purpose.  
\*\* not used  
CGND is the chassis ground

02.03.99	AJ	AJ	--		
Date	S	TZ	Off. in ch.	contr. techn.	contr. Norm



**D-TR-3504E**

Dept.: PA-VP	Nr. <b>36-9281</b>
Up date: 19.03.04	Replaces: XXXXX / 36-XXXX
Scale: - : -	Sheet 2 of 2

copyright according to DIN34  
unauthorized distribution and reproduction prohibited

# 3564 DIGITAL INPUT MODULE

Simplified schematic of a typical 64-point commoned 24 VDC digital input module  
(1 of 64 points shown)

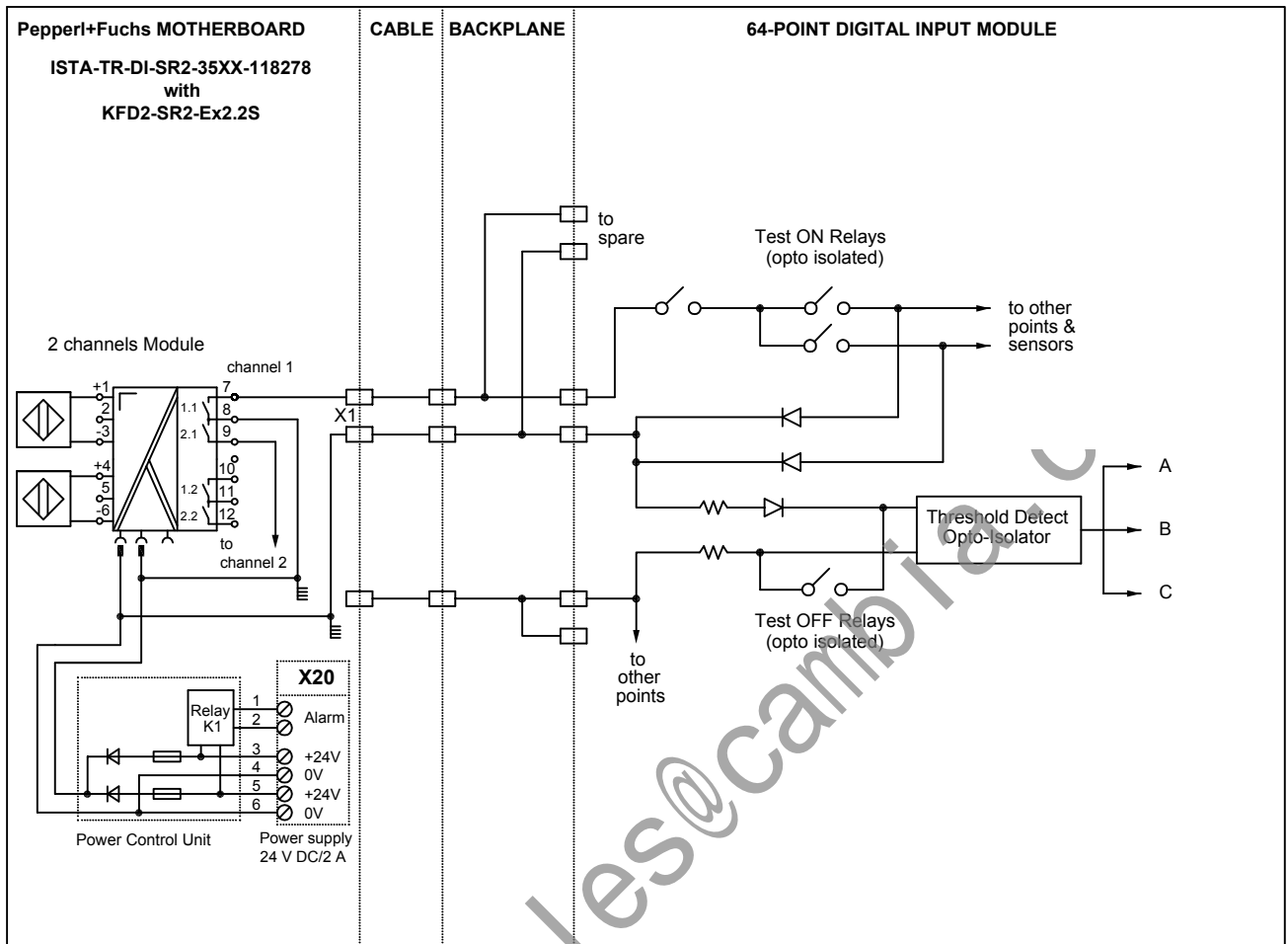

## Pin assignment of connector #A (56 pin ELCO female)

Pin	AA	KK	LL	z	DD	EE	p	u	v	h	k	l	e	a
Signal	IN1	*	IN2	IN3	PWR	IN4	IN5	*	IN6	IN7	PWR	IN8	IN9	*
Pin	b	W	R	S	L	E	F	M	A	B	BB	NN	MM	CC
Signal	IN10	IN11	PWR	IN12	IN13	RTN	IN14	IN15	RTN	IN16	IN17	RTN	IN18	IN19
Pin	JJ	HH	t	y	x	j	n	m	f	d	c	Z	V	U
Signal	RTN	IN20	IN21	RTN	IN22	IN23	RTN	IN24	IN25	RTN	IN26	IN27	RTN	IN28
Pin	P	K	J	N	D	C	T	H	w	FF	r	s	X	Y
Signal	IN29	RTN	IN30	IN31	RTN	IN32	CGND	CGND	CGND	CGND	**	**	**	**

## Pin assignment of connector #B (56 pin ELCO female)

Pin	AA	KK	LL	z	DD	EE	p	u	v	h	k	l	e	a
Signal	IN33	RTN	IN34	IN35	PWR	IN36	IN37	RTN	IN38	IN39	PWR	IN40	IN41	RTN
Pin	b	W	R	S	L	E	F	M	A	B	BB	NN	MM	CC
Signal	IN42	IN43	PWR	IN44	IN45	RTN	IN46	IN47	RTN	IN48	IN49	RTN	IN50	IN51
Pin	JJ	HH	t	y	x	j	n	m	f	d	c	Z	V	U
Signal	RTN	IN52	IN53	RTN	IN54	IN55	RTN	IN56	IN57	RTN	IN58	IN59	RTN	IN60
Pin	P	K	J	N	D	C	T	H	w	FF	r	s	X	Y
Signal	IN61	RTN	IN62	IN63	RTN	IN64	CGND	CGND	CGND	CGND	**	**	**	**

\* Reserved for internal use. Do not connect for any purpose.  
\*\* not used  
CGND is the chassis ground

02.03.99		AJ	AJ	--	
Date	S	TZ	Off. in ch.	contr. techn.	contr. Norm
Dept.:	PA-VP	Nr. <b>36-9282</b>			
Up date:	vB/Bro 19.03.04	Replaces: XXXXX / 36-XXXX			Sheet 1
Scale:				- : -	of 2



PEPPERL+FUCHS  
Mannheim-Schönau

D-TR-3564

# 3564 DIGITAL INPUT MODULE

Simplified schematic of a typical 64-point commoned 24 VDC digital input module  
(1 of 64 points shown)

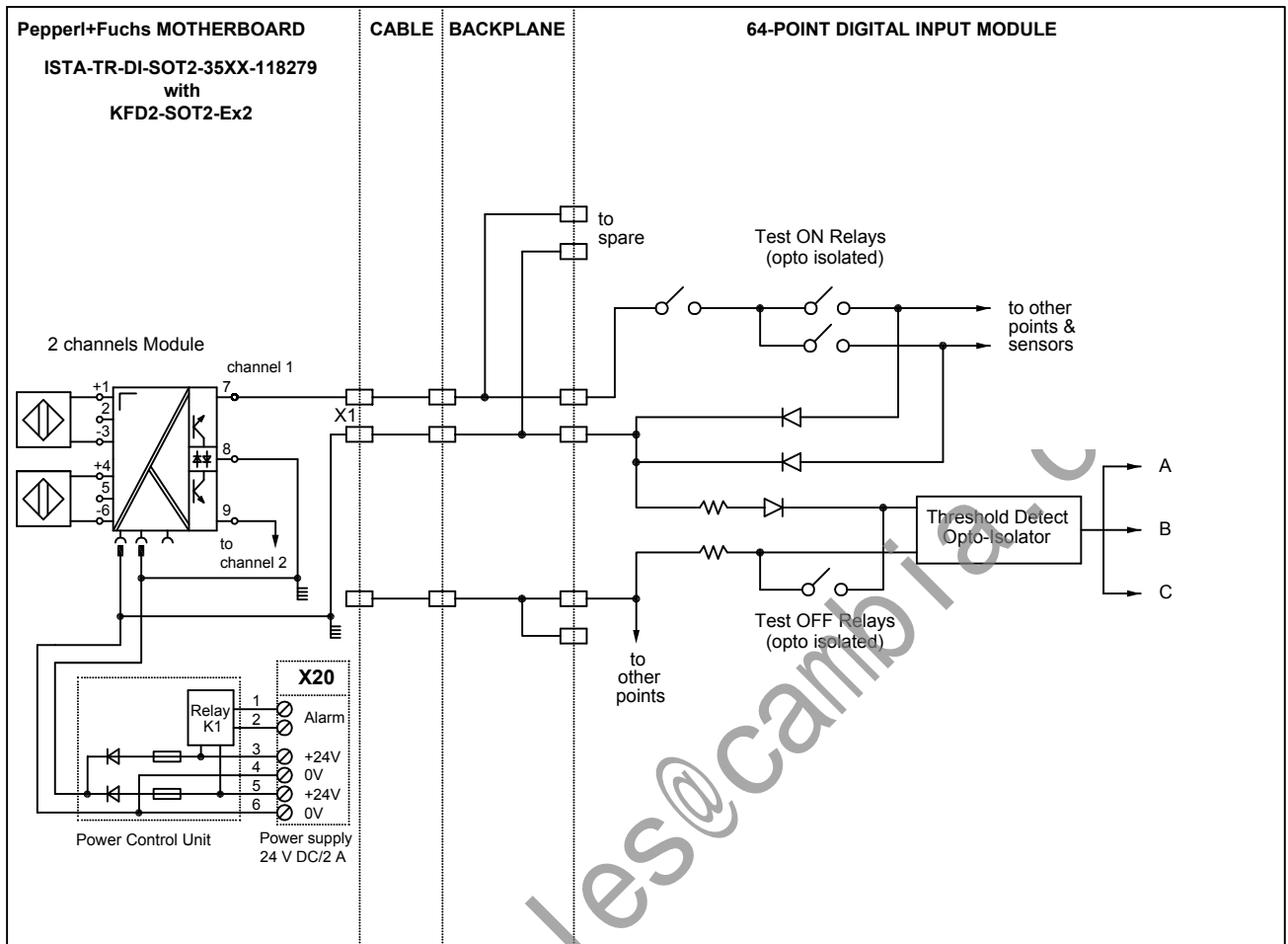

## Pin assignment of connector #A (56 pin ELCO female)

Pin	AA	KK	LL	z	DD	EE	p	u	v	h	k	l	e	a
Signal	IN1	*	IN2	IN3	PWR	IN4	IN5	*	IN6	IN7	PWR	IN8	IN9	*
Pin	b	W	R	S	L	E	F	M	A	B	BB	NN	MM	CC
Signal	IN10	IN11	PWR	IN12	IN13	RTN	IN14	IN15	RTN	IN16	IN17	RTN	IN18	IN19
Pin	JJ	HH	t	y	x	j	n	m	f	d	c	Z	V	U
Signal	RTN	IN20	IN21	RTN	IN22	IN23	RTN	IN24	IN25	RTN	IN26	IN27	RTN	IN28
Pin	P	K	J	N	D	C	T	H	w	FF	r	s	X	Y
Signal	IN29	RTN	IN30	IN31	RTN	IN32	CGND	CGND	CGND	CGND	**	**	**	**

## Pin assignment of connector #B (56 pin ELCO female)

Pin	AA	KK	LL	z	DD	EE	p	u	v	h	k	l	e	a
Signal	IN33	RTN	IN34	IN35	PWR	IN36	IN37	RTN	IN38	IN39	PWR	IN40	IN41	RTN
Pin	b	W	R	S	L	E	F	M	A	B	BB	NN	MM	CC
Signal	IN42	IN43	PWR	IN44	IN45	RTN	IN46	IN47	RTN	IN48	IN49	RTN	IN50	IN51
Pin	JJ	HH	t	y	x	j	n	m	f	d	c	Z	V	U
Signal	RTN	IN52	IN53	RTN	IN54	IN55	RTN	IN56	IN57	RTN	IN58	IN59	RTN	IN60
Pin	P	K	J	N	D	C	T	H	w	FF	r	s	X	Y
Signal	IN61	RTN	IN62	IN63	RTN	IN64	CGND	CGND	CGND	CGND	**	**	**	**

\* Reserved for internal use. Do not connect for any purpose.  
\*\* not used  
CGND is the chassis ground

02.03.99		AJ	AJ	--	
Date	S	TZ	Off. in ch.	contr. techn.	contr. Norm
Dept.:	PA-VP	Nr. <b>36-9282</b>			
Up date:	vB/Bro 19.03.04	Replaces: XXXXX / 36-XXXX			Sheet 2
Scale:				- : -	of 2



PEPPERL+FUCHS  
Mannheim-Schönau

D-TR-3564



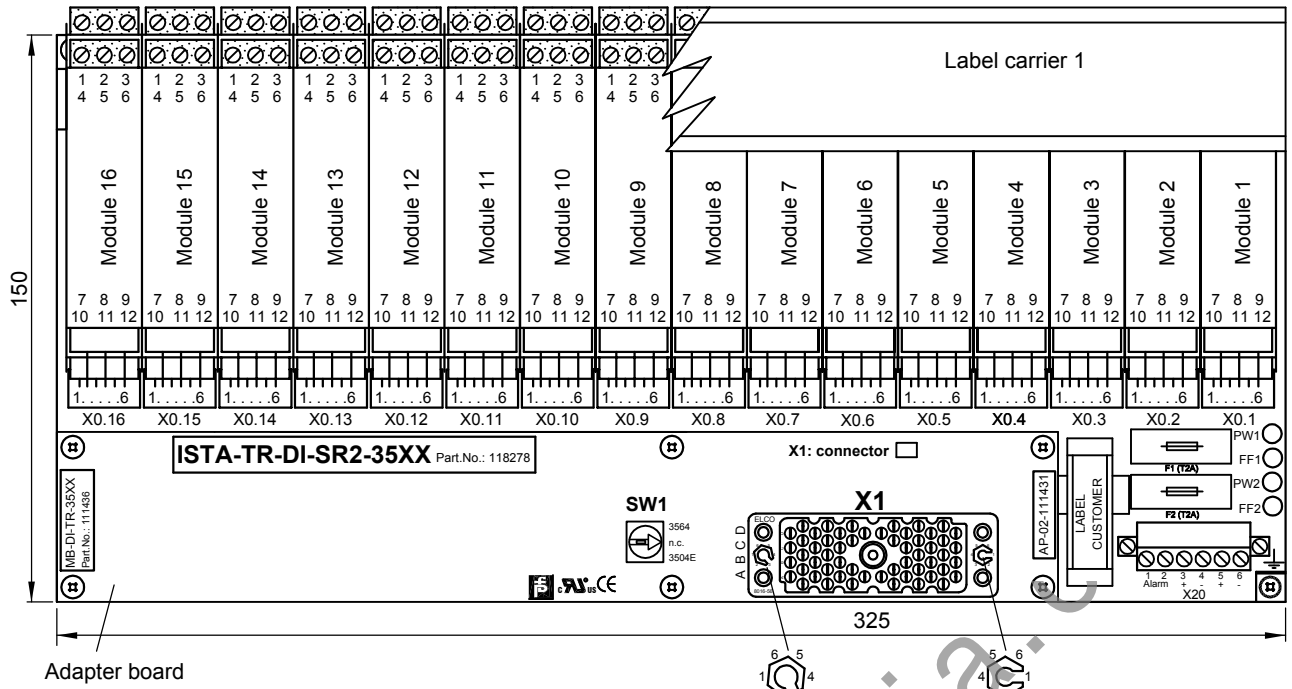

**APPLICATION:**

**TRICONEX I/O card 3504E / 3564:** will be required 2 x ISTA-TR-DI-SR2-35XX-118278  
32 + 32 points, commoned

Motherboard 2: connected with connector #B  
Module 1 ... 16, channels 17 ... 32

Motherboard 1: connected with connector #A  
Module 1 ... 16, channels 17 ... 32

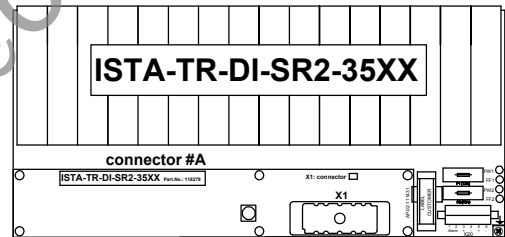
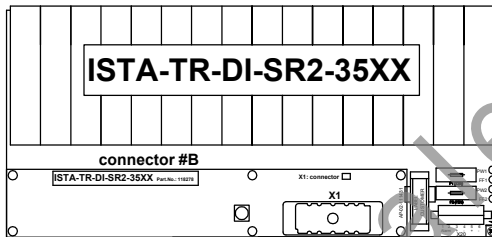

Name	Note
X1	56 pin female system connector ELCO (small key: 1, large key: 3)
----	----
X0.1 .... 16	6 pin male terminals for cable tree FSY....
X20.3 .... 6	Power supply screw terminals
X20.1, X20.2	Alarm screw terminal
F1, F2	Fuse
PW1, PW2, FF1, FF2	LEDs for power and power failure

**Ordering information: ISTA-TR-DI-SR2-35XX-118278**

Basic components:	Description
<b>16 pieces:</b> KFD2-SR2-Ex2.2S (DI)	KF-Module type (function)
<b>1 piece:</b> MB-DI-TR-35XX-111436	Motherboard without modules
<b>composed by:</b>	
1 piece: MB-16U5L-103681	Motherboard without modules, adapter board, FSY cable tree and Label carrier
1 piece: AP-02-111431	Adapter board
1 piece: KFD0-LC1-16M-99144	Label carrier 1
16 pieces: FSY-L456-98837	Cable tree connection KF-Module-Motherboard

copyright according to DIN34 unauthorized distribution and reproduction prohibited

	<b>PEPPERL+FUCHS</b> Mannheim-Schönau	Motherboard unit Digital Input 32 channels <b>ISTA-TR-DI-SR2-35XX</b>	18.03.02	KT	vB	vB/Sb		
			Date	S	TZ	Off. in ch.	contr. techn.	contr. Norm
			Dept.: PA-VP	Nr. <b>36-7361</b>				
			Up date: 19.03.04	Replaces: vB/Bro xxxxx / 36-xxxx			Sheet 1	
		MB-16U5L	Scale: 1 : 2, 1 : 5	of 3				

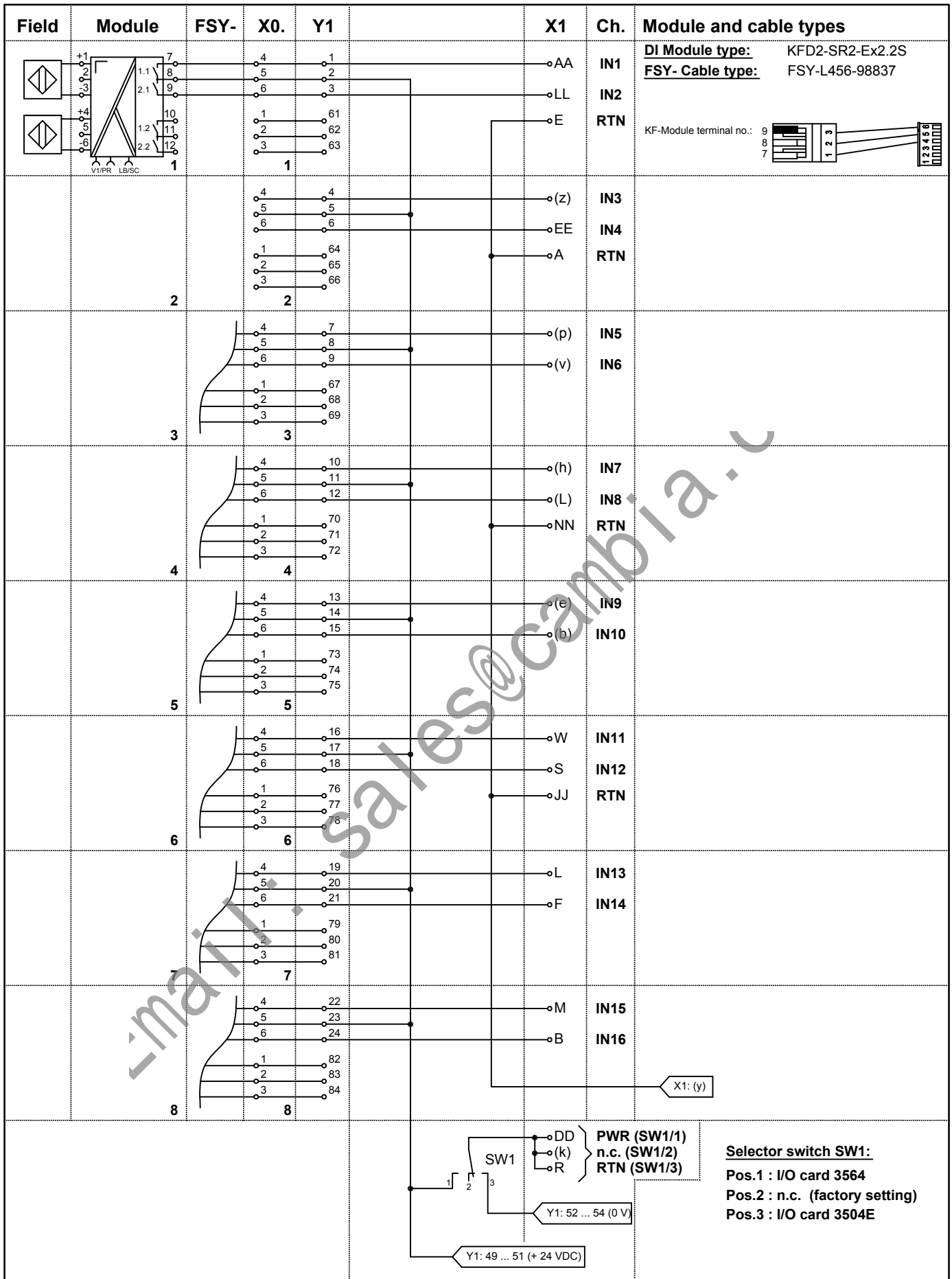

copyright according to DIN34 unauthorized distribution and reproduction prohibited

	Note: Letters in brackets are small letters				
	18.03.02		KT	vB	vB/Sb
	Date	S	TZ	Off. in ch.	contr. techn.
	Dept.: PA-VP Up date: 19.03.04		Nr. <b>36-7361</b> Replaces: xxxxx / 36-xxxx		
<b>Motherboard unit</b> <b>Digital Input</b> <b>32 channels</b> <b>ISTA-TR-DI-SR2-35XX</b>					Sheet 2 of 3

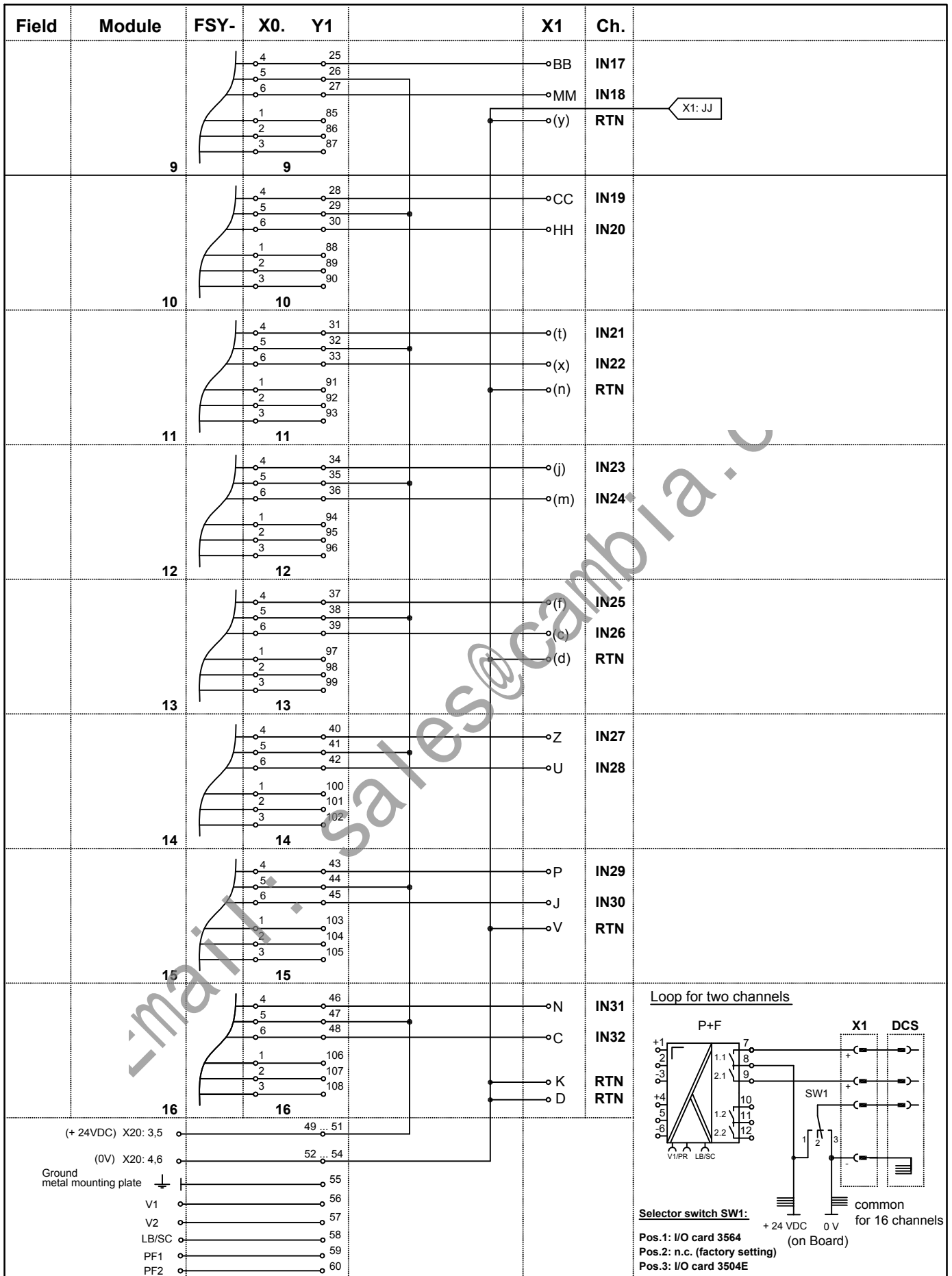

copyright according to DIN34  
unauthorized distribution and reproduction prohibited

		Note: Letters in brackets are small letters			
		18.03.02	KT	vB	vB/Sb
Date	S TZ	Off. in ch.	contr. techn.	contr. Norm	
Dept.: PA-VP	<b>Nr. 36-7361</b>				
Up date: 19.03.04	vB/Bro	Replaces:	xxxxx / 36-xxxx	Sheet 3	
--	Scale:	--	of	3	

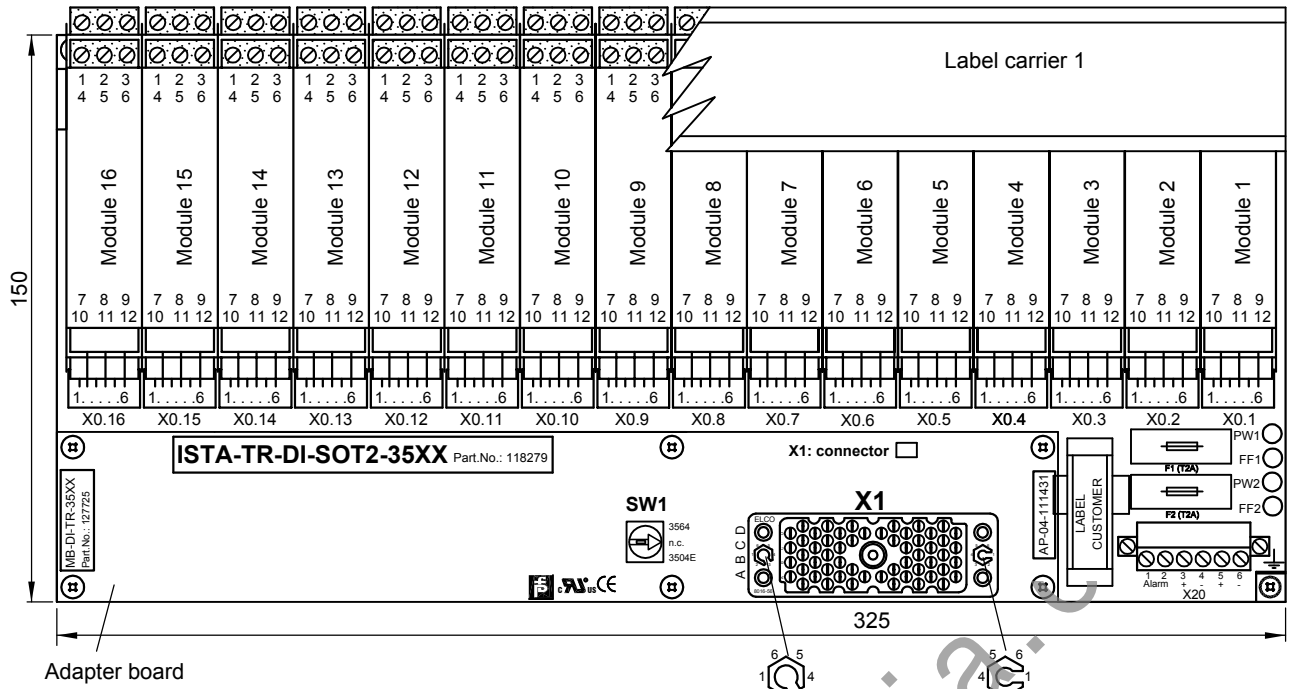

**APPLICATION:**

**TRICONEX I/O card 3504E / 3564:** will be required 2 x ISTA-TR-DI-SOT2-35XX-118279  
32 + 32 points, commoned

Motherboard 2: connected with connector #B  
Module 1 ... 16, channels 17 ... 32

Motherboard 1: connected with connector #A  
Module 1 ... 16, channels 17 ... 32

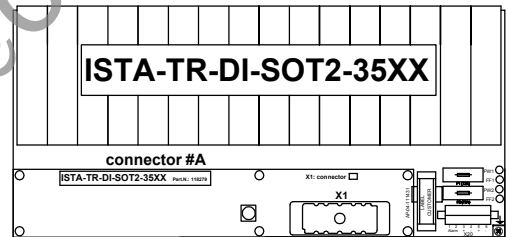
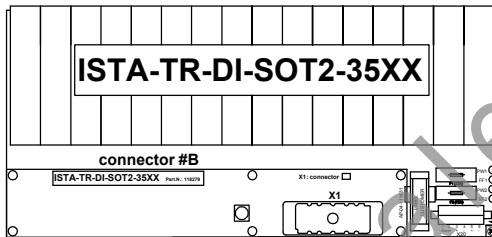

Name	Note
X1	56 pin female system connector ELCO (small key: 1, large key: 3)
----	---
X0.1 .... 16	6 pin male terminals for cable tree FSY....
X20.3 .... 6	Power supply screw terminals
X20.1, X20.2	Alarm screw terminal
F1, F2	Fuse
PW1, PW2, FF1, FF2	LEDs for power and power failure

**Ordering information: ISTA-TR-DI-SOT2-35XX-118279**

Basic components:	Description
<b>16 pieces:</b> KFD2-SOT2-Ex2 (DI)	KF-Module type (function)
<b>1 piece:</b> MB-DI-TR-35XX-127725	Motherboard without modules
<b>composed by:</b>	
1 piece: MB-16U5L-103681	Motherboard without modules, adapter board, FSY cable tree and Label carrier
1 piece: AP-04-111431	Adapter board
1 piece: KFD0-LC1-16M-99144	Label carrier 1
16 pieces: FSY-L456-98837	Cable tree connection KF-Module-Motherboard

copyright according to DIN34 unauthorized distribution and reproduction prohibited

	<b>PEPPERL+FUCHS</b> Mannheim-Schönau	Motherboard unit Digital Input 32 channels <b>ISTA-TR-DI-SOT2-35XX</b>	18.03.02	KT	vB	vB/Sb	
			Date	S TZ	Off. in ch.	contr. techn.	contr. Norm
			Dept.: PA-VP	<b>Nr. 36-7188</b>			
			Up date: 22.03.04	Replaces: vB/Bro xxxxx / 36-xxxx	Sheet 1		
		MB-16U5L	Scale: 1 : 2, 1 : 5	of 3			

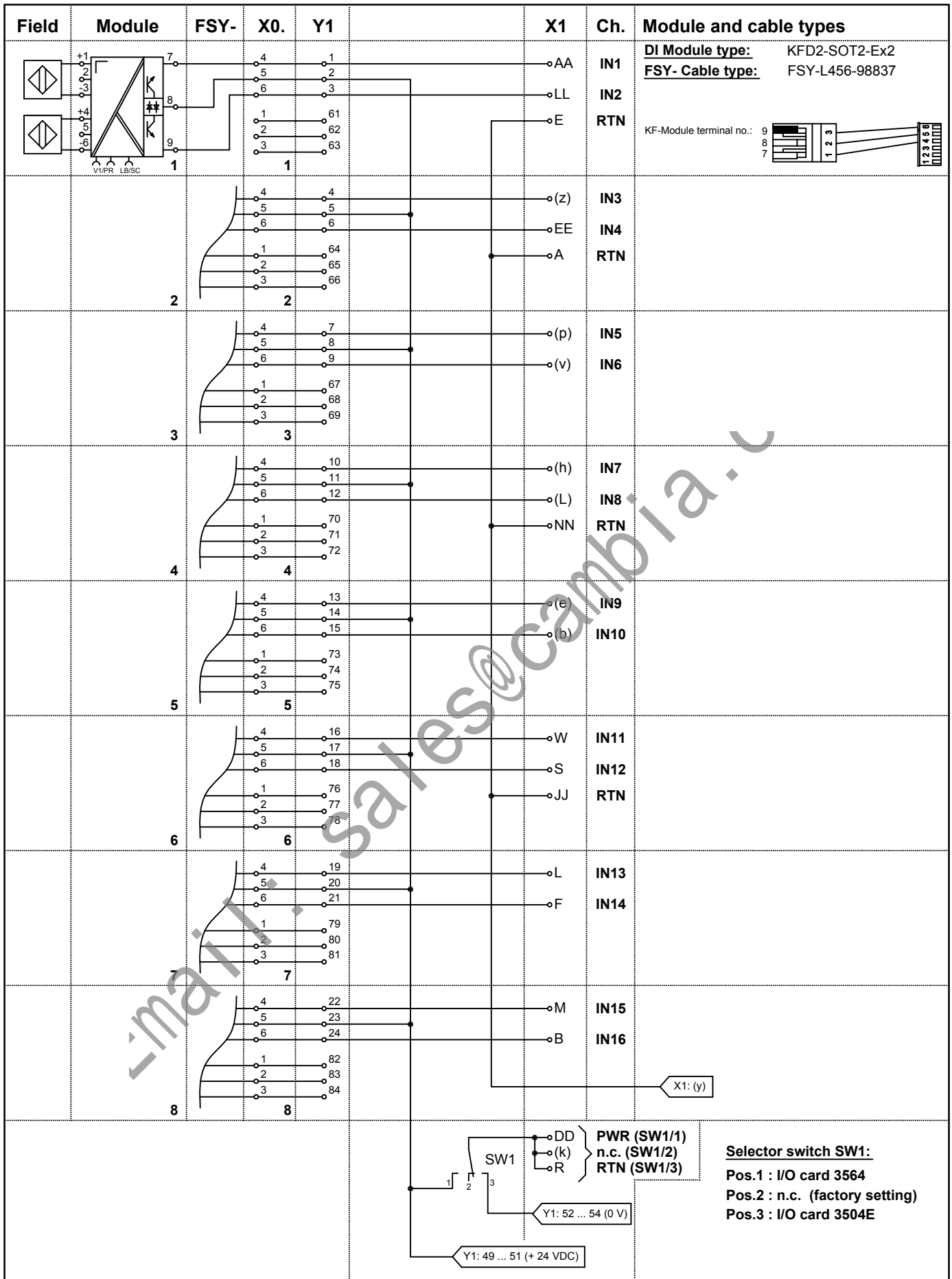

copyright according to DIN34 unauthorized distribution and reproduction prohibited

	Note: Letters in brackets are small letters				
	21.03.02		KT	vB	vB/Sb
	Date	S	TZ	Off. in ch.	contr. techn.
	Dept.: PA-VP Up date: 22.03.04		Nr. <b>36-7188</b> Replaces: xxxxx / 36-xxxx		
<b>Motherboard unit</b> <b>Digital Input</b> <b>32 channels</b> <b>ISTA-TR-DI-SOT2-35XX</b>					Sheet 2 of 3

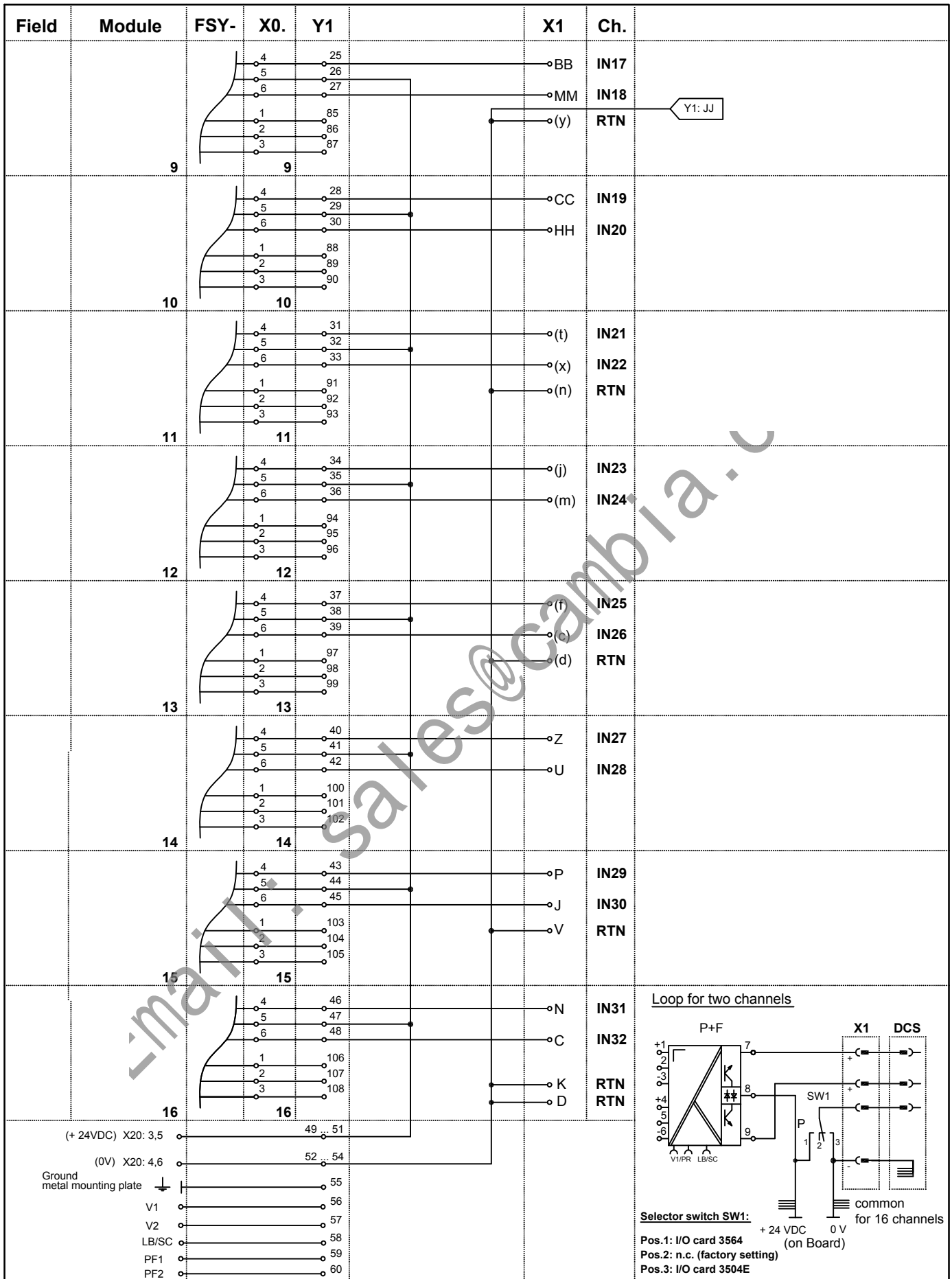

copyright according to DIN34  
 unauthorized distribution and reproduction prohibited

		Date		KT	vB	vB/Sb	
		S	TZ		Off. in ch.	contr. techn.	contr. Norm
		Dept.: PA-VP		Nr. <b>36-7188</b>			
		Up date: 22.03.04		Replaces: xxxxx / 36-xxxx		Sheet 3	
		--		Scale: - : -		of 3	



Motherboard unit  
 Digital Input  
 32 channels  
**ISTA-TR-DI-SOT2-35XX**

## 4. 3511 Application

(8 channels DI)

Page

**Motherboard MB-DI-TR-3511-183386..... 4- 1**

**Part No.:** 183386  
**Function:** Digital Input  
**Channels:** 8  
**System cable:** (ELCO connector)  
**KF- Module:** KFD2-SOT2-EX1.LW (single channel)

**Wiring Diagram:** drawing no. 36-7697

email: sales@cambia.a.c

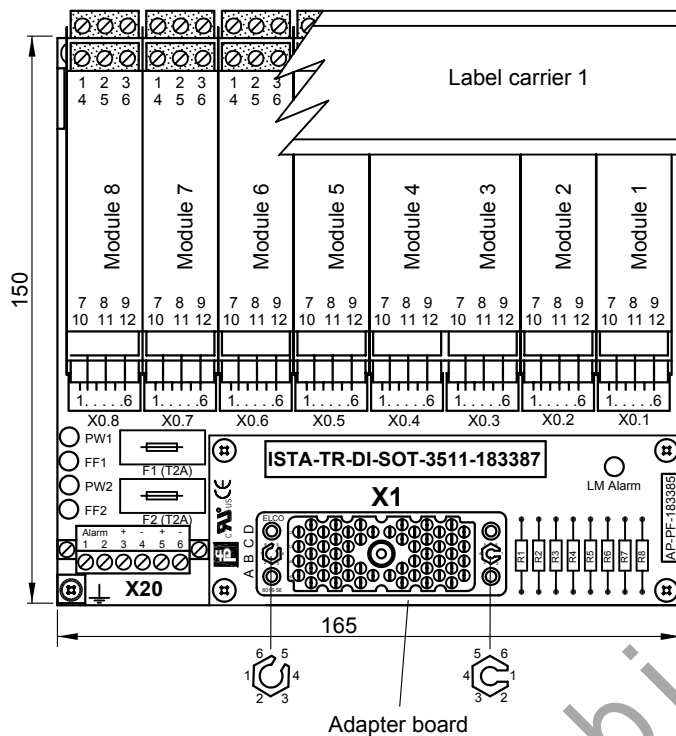

**APPLICATION:**

**TRICONEX I/O card 3511 with KF-module KFD2-SOT2-Ex1.LB:**  
8 points (Pulse 1Hz...5000Hz)

Name	Note
X1	56 pin female system connector ELCO (small key: 1, large key: 5)
R1...R8	Termination resistor 4K7
X0.1 .... 8	6 pin male terminals for cable tree FSY....
X20.3 .... 6	Power supply screw terminals
X20.1...2	Alarm screw terminal
F1, F2	Fuse T2A
PW1, PW2, FF1, FF2	LEDs for power and power failure

**Ordering information: ISTA-TR-DI-SOT-3511-183387**

Basic components:	Description
<b>8 pieces:</b> KFD2-SOT2-Ex1.LB (DI)	KF-Module type (function)
<b>1 piece:</b> MB-DI-TR-3511-183386	Motherboard without modules
<b>composed by:</b>	
1 piece: MB-8U2-Y97680	Motherboard without modules, adapter board, FSY cable tree and Label carrier
1 piece: AP-PF-183385	Adapter board
1 piece: KFD0-LC1-8M-99143	Label carrier 1
8 pieces: FSY-L450-98833	Cable tree connection KF-Module-Motherboard

copyright according to DIN34  
unauthorized distribution and reproduction prohibited

	<b>PEPPERL+FUCHS</b> Mannheim-Schönau	Motherboard unit Digital Input (Pulse) 8 channels <b>ISTA-TR-DI-SOT-3511-.....</b>	10.05.05	Sb	Sb	vB/Sb		
			Date	S	TZ	Off. in ch.	contr. techn.	contr. Norm
			Dept.: PA-VP	Nr. <b>36-7697</b>		Replaces: xxxxxx/ 36-xxxx		Sheet 1
			Up date: xx/xx/xx	MB-8U2	Scale: 1 : 2	of 2		



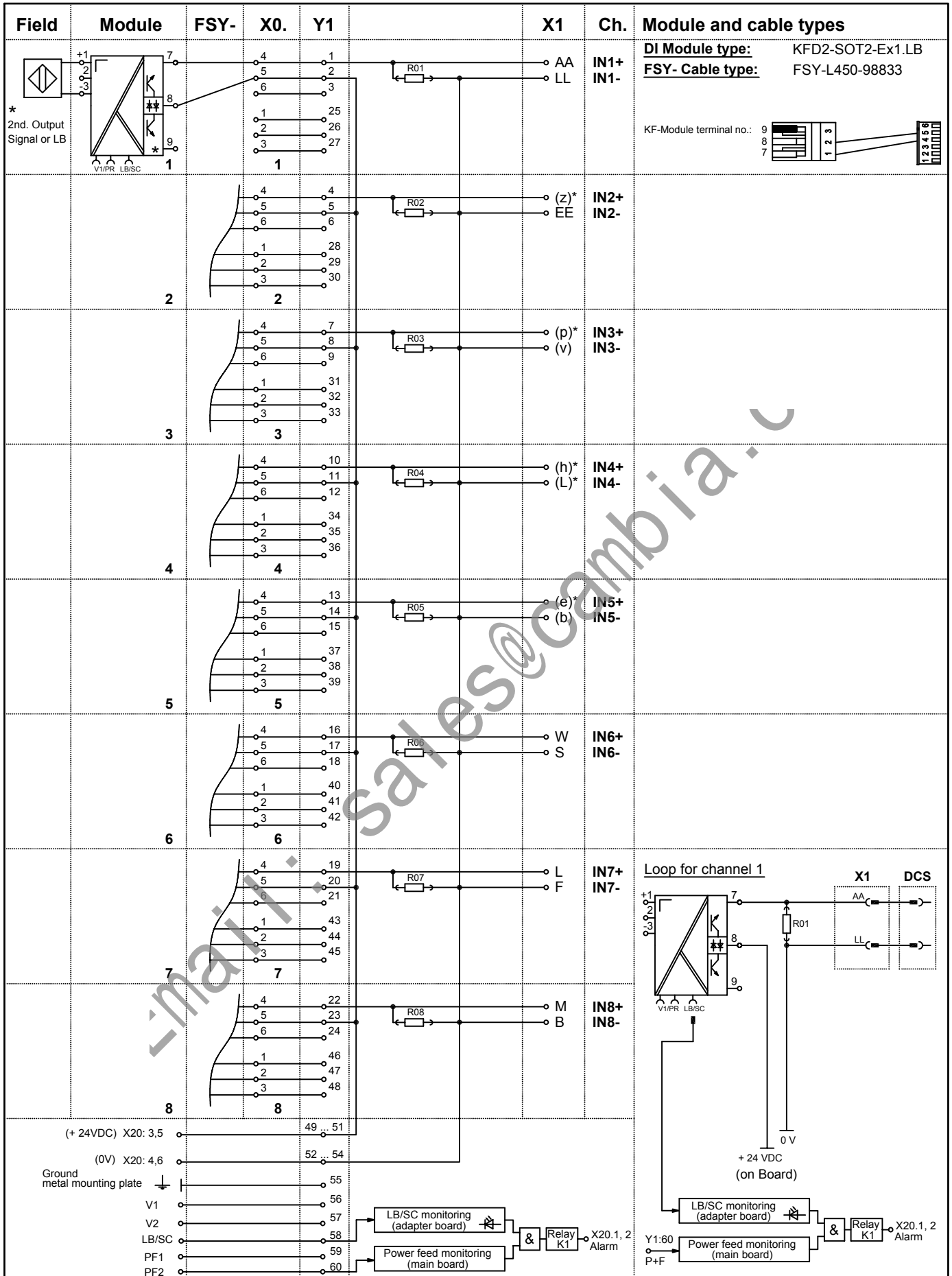

	Motherboard unit Digital Input (Pulse) 8 channels <b>ISTA-TR-DI-SOT-3511-.....</b>		08.07.05	Sb	Sb	Sb/vB	
	Date	S TZ	Off.	in ch.	contr.	techn.	contr. Norm
	Dept.: PA-VP	Nr. <b>36-7697</b>		Replaces:		Sheet 2	
	Up date: xx/xx	xxxxxx/ 36-xxxx		Scale:		of 2	

## 5. 3604E / 3624 Application

(16 channels DO)

	Page
<b>Simplified schematic 3604E / 3624</b> .....	5- 1
<b>Motherboard ISTA-TR-DO-SD-36XX-118274</b> .....	5- 2
<b>Part No.:</b>	118274
<b>Function:</b>	Digital Output
<b>Channels:</b>	16
<b>System cable:</b>	(ELCO connector)
<b>KF- Module:</b>	KFD2-SD-Ex1.48... (single channel)
<b>Simplified schematic:</b>	drawing no. 36-9284
<b>Wiring Diagram:</b>	drawing no. 36-7430
<b>Simplified schematic 3604E</b> .....	5- 5
<b>Motherboard ISTA-TR-DO-SL2-36XX-118273</b> .....	5- 6
<b>Part No.:</b>	118273
<b>Function:</b>	Digital Output
<b>Channels:</b>	16
<b>System cable:</b>	(ELCO connector)
<b>KF- Module:</b>	KFD2-SL2-Ex2.B (dual channel)
<b>Simplified schematic:</b>	drawing no. 36-9285
<b>Wiring Diagram:</b>	drawing no. 36-7363
<b>Motherboard ISTA-TR-DO-SL2-36XX-118288</b> .....	5- 8
<b>Part No.:</b>	118288
<b>Function:</b>	Digital Output
<b>Channels:</b>	16
<b>System cable:</b>	(ELCO connector)
<b>KF- Module:</b>	KFD2-SL2-Ex2 (dual channel)
<b>Simplified schematic:</b>	drawing no. 36-9285
<b>Wiring Diagram:</b>	drawing no. 36-7358

# 3604E DIGITAL OUTPUT MODULE

Simplified schematic of a typical 16-point digital output module  
(1 of 16 points shown)

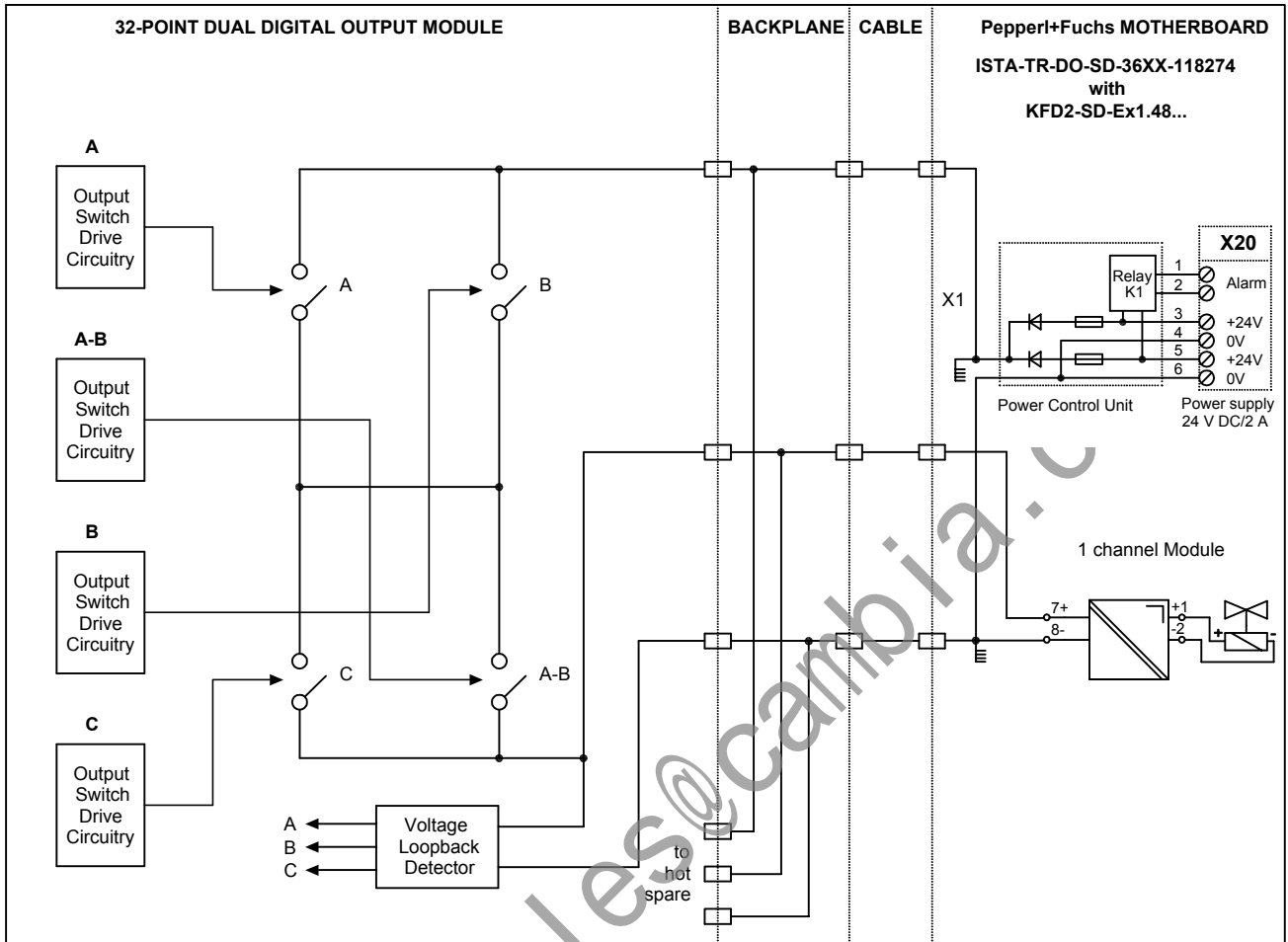

## Pin assignment of connector #A (56 pin ELCO female)

<b>Pin</b>	AA	KK	LL	z	DD	EE	p	u	v	h	k	l	e	a
<b>Signal</b>	PWR1	LOAD1	RTN1	PWR2	LOAD2	RTN2	PWR3	LOAD3	RTN3	PWR4	LOAD4	RTN4	PWR5	LOAD5
<b>Pin</b>	b	W	R	S	L	E	F	M	A	B	BB	NN	MM	CC
<b>Signal</b>	RTN5	PWR6	LOAD6	RTN6	PWR7	LOAD7	RTN7	PWR8	LOAD8	RTN8	PWR9	LOAD9	RTN9	PWR10
<b>Pin</b>	JJ	HH	t	y	x	j	n	m	f	d	c	Z	V	U
<b>Signal</b>	LOAD10	RTN10	PWR11	LOAD11	RTN11	PWR12	LOAD12	RTN12	PWR13	LOAD13	RTN13	PWR14	LOAD14	RTN14
<b>Pin</b>	P	K	J	N	D	C	T	H	w	FF	r	s	X	Y
<b>Signal</b>	PWR15	LOAD15	RTN15	PWR16	LOAD16	RTN16	CGND	CGND	CGND	CGND	**	**	**	**

** not used	CGND is the chassis ground	02.03.99	AJ	AJ	--	
		Date	S TZ	Off. in ch.	contr. techn.	contr. Norm

<b>PEPPERL+FUCHS</b> Mannheim-Schönau	<b>D-TR-3604E</b>	Dept.: PA-VP	<b>Nr. 36-9284</b>
		vB/Bro	Replaces: XXXXX / 36-XXXX
		Up date: 22.03.04	Sheet 1
		Scale: - : -	of 1

copyright according to DIN34  
unauthorized distribution and reproduction prohibited

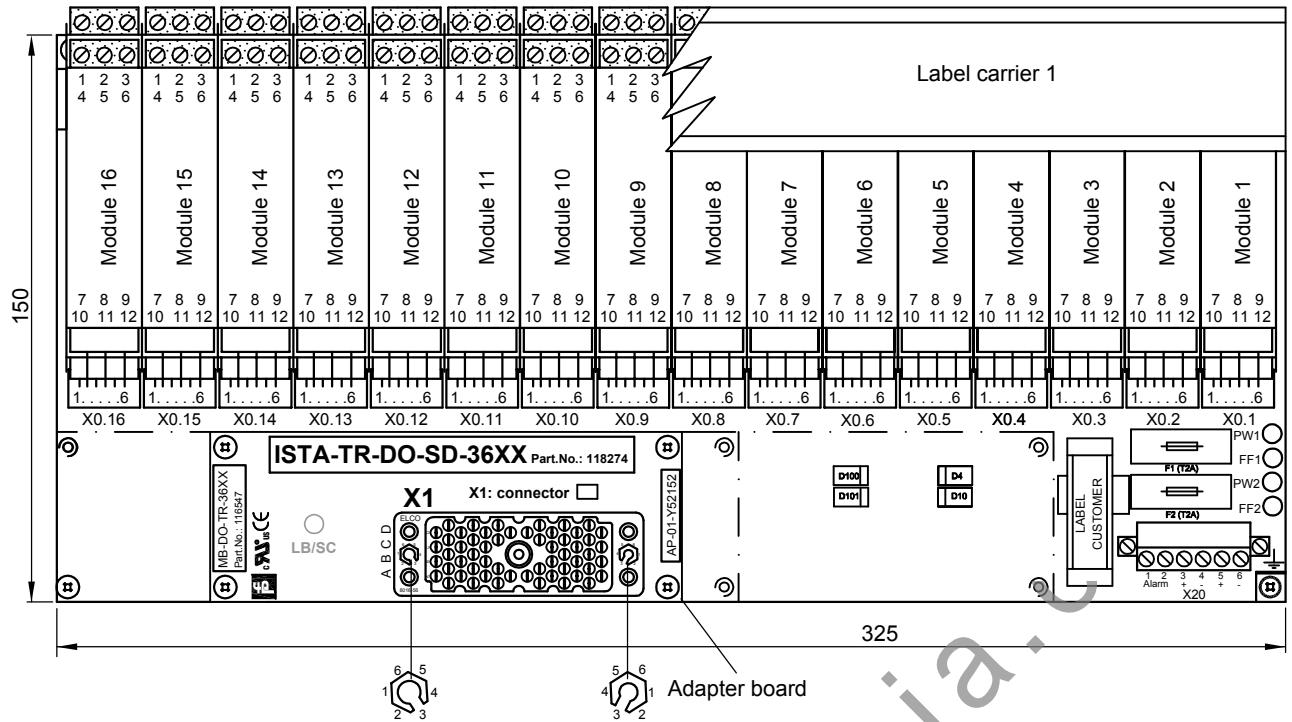

**APPLICATION:**  
**TRICONEX I/O card 3604E:**  
 16 points, non commoned

Motherboard 1: connected with connector #A  
 Module 1 ... 16, channels 1 ... 16

**APPLICATION:**  
**TRICONEX I/O card 3664:** will be required 2 x ISTA-TR-DO-SD-36XX-118274  
 16 + 16 points, non commoned, diff., DC coupled

Motherboard 2: connected with connector #B  
 Module 1 ... 16, channels 1 ... 16

Motherboard 1: connected with connector #A  
 Module 1 ... 16, channels 1 ... 16

Name	Note
X1	56 pin female system connector ELCO (small key: 3, large key: 3)
----	----
X0.1 .... 16	6 pin male terminals for cable tree FSY....
X20.3 .... 6	Power supply screw terminals
X20.1, X20.2	Alarm screw terminal
F1, F2	Fuse
PW1, PW2, FF1, FF2	LEDs for power and power failure

Ordering information: ISTA-TR-DO-SD-36XX-118274		
Basic components:	Description	
<b>16 pieces:</b>	<b>KFD2-SD-Ex1.48... (DO)</b>	KF-Module type (function)
<b>1 piece:</b>	<b>MB-DO-TR-36XX-116547</b>	Motherboard without modules
<b>composed by:</b>		
1 piece:	MB-16U5L-103681	Motherboard without modules, adapter board, FSY cable tree and Label carrier
1 piece:	AP-01-Y52152	Adapter board
1 piece:	KFD0-LC1-16M-99144	Label carrier 1
16 pieces:	FSY-L450-98833	Cable tree connection KF-Module-Motherboard

copyright according to DIN34 unauthorized distribution and reproduction prohibited

	<b>PEPPERL+FUCHS</b> <b>Mannheim-Schönau</b>	Motherboard unit Digital Output <b>16 channels</b> <b>ISTA-TR-DO-SD-36XX</b>	21.03.02	KT	vB	vB/Sb		
			Date	S	TZ	Off. in ch.	contr. techn.	contr. Norm
			Dept.:	PA-VP	<b>Nr. 36-7430</b>			
			Up date:	vB/Bro 22.03.04	Replaces:	116547 / 36-7621	Sheet	1
	MB-16U5L	Scale:	1 : 2 (1 : 8)	of	3			

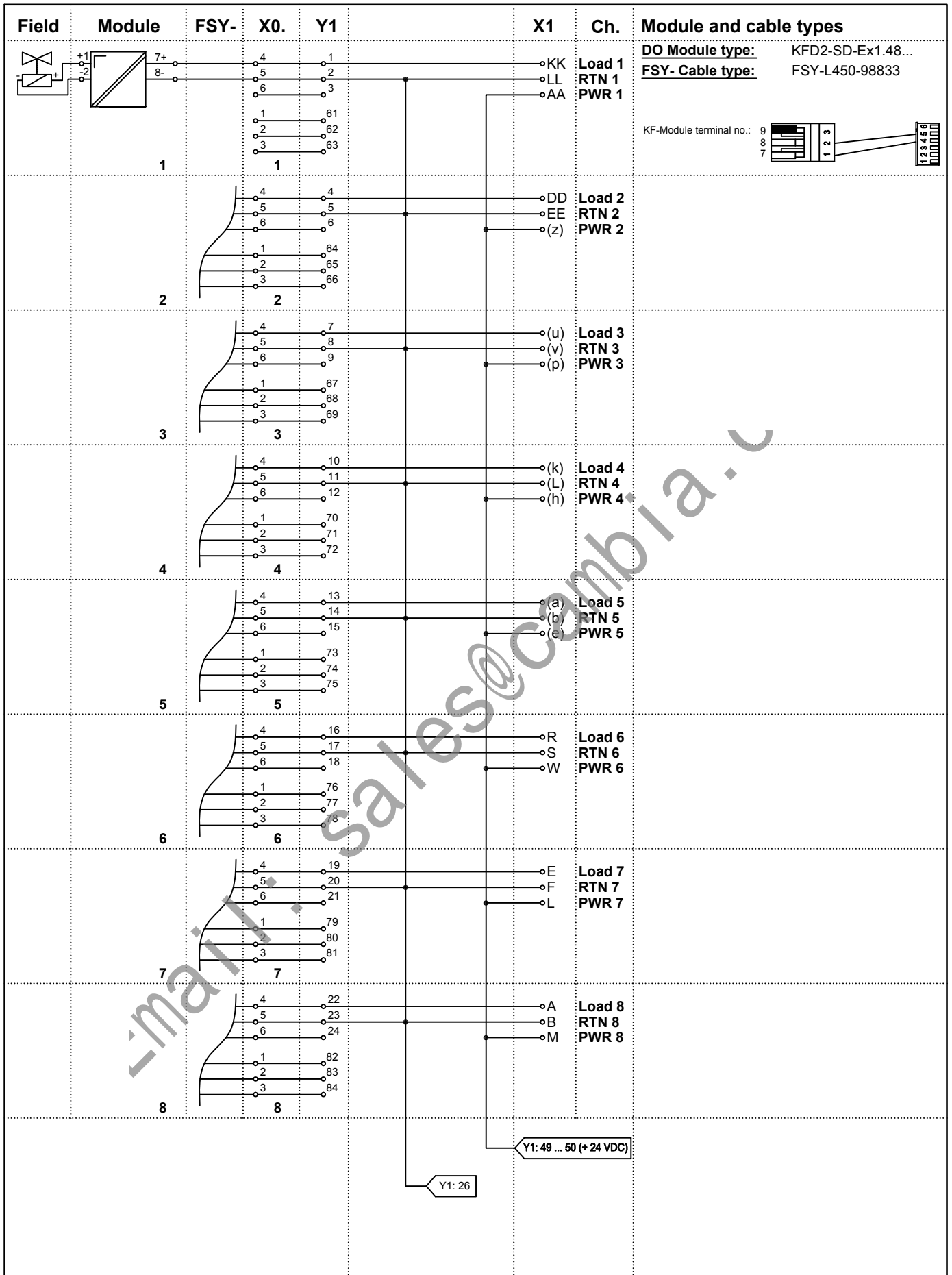

Email: sales@cambia.it

copyright according to DIN34 unauthorized distribution and reproduction prohibited

	<b>PEPPERL+FUCHS</b> Mannheim-Schönau	Motherboard unit Digital Output <b>16 channels</b> <b>ISTA-TR-DO-SD-36XX</b>	21.03.02		KT	vB	vB/Sb			
			Date	S	TZ	Off. in ch.	contr. techn.	contr. Norm		
			Dept.:	PA-VP		<b>Nr. 36-7430</b>				
			Up date:	vB/Bro 22.03.04		Replaces: 116547 / 36-7621		Sheet 2		
			MB-16U5L	Scale:			of 3			



# 3604E DIGITAL OUTPUT MODULE

Simplified schematic of a typical 16-point digital output module  
(1 of 16 points shown)

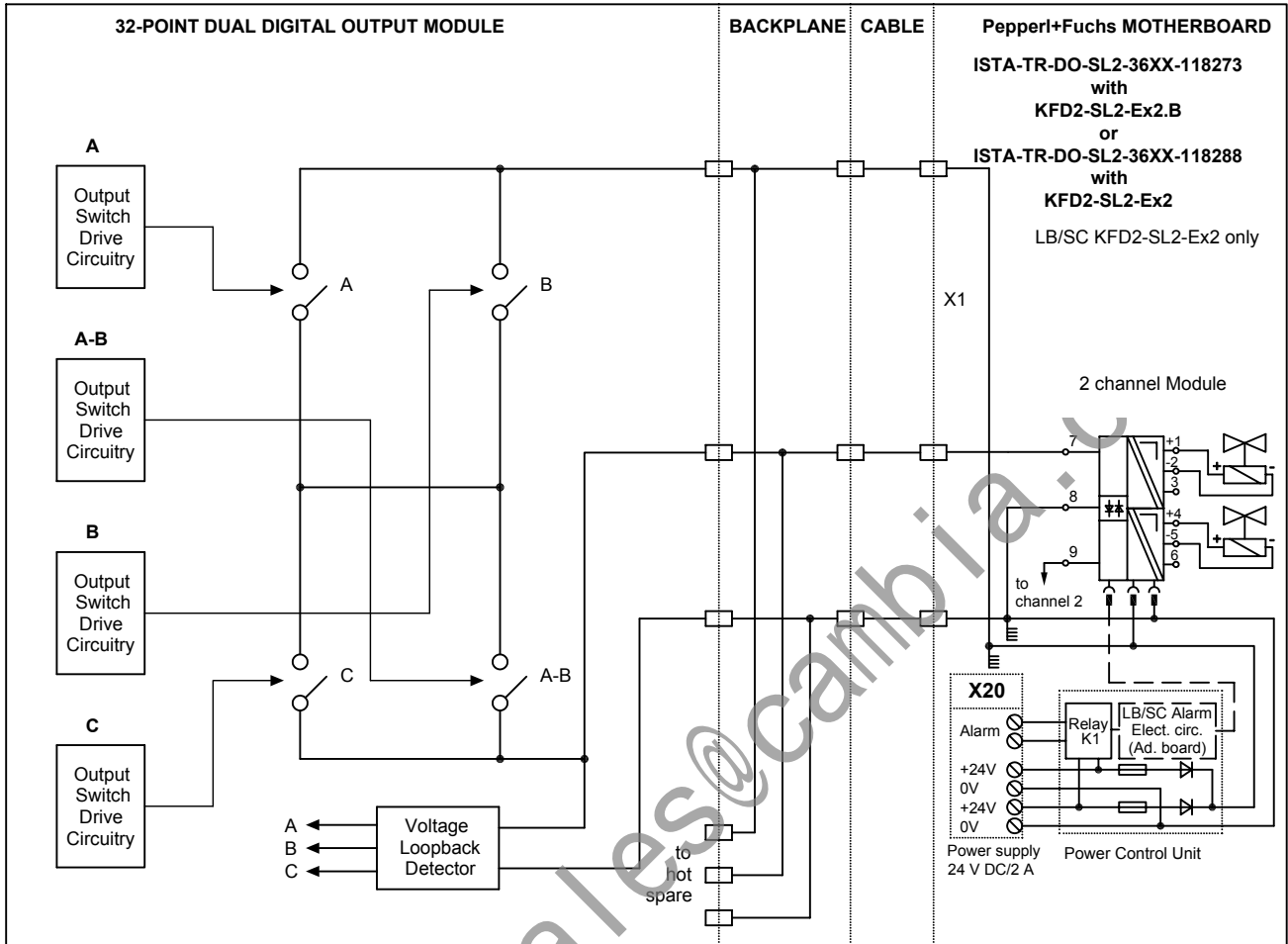

## Pin assignment of connector #A (56 pin ELCO female)

Pin	AA	KK	LL	z	DD	EE	p	u	v	h	k	l	e	a
Signal	PWR1	LOAD1	RTN1	PWR2	LOAD2	RTN2	PWR3	LOAD3	RTN3	PWR4	LOAD4	RTN4	PWR5	LOAD5
Pin	b	W	R	S	L	E	F	M	A	B	BB	NN	MM	CC
Signal	RTN5	PWR6	LOAD6	RTN6	PWR7	LOAD7	RTN7	PWR8	LOAD8	RTN8	PWR9	LOAD9	RTN9	PWR10
Pin	JJ	HH	t	y	x	j	n	m	f	d	c	Z	V	U
Signal	LOAD10	RTN10	PWR11	LOAD11	RTN11	PWR12	LOAD12	RTN12	PWR13	LOAD13	RTN13	PWR14	LOAD14	RTN14
Pin	P	K	J	N	D	C	T	H	w	FF	r	s	X	Y
Signal	PWR15	LOAD15	RTN15	PWR16	LOAD16	RTN16	CGND	CGND	CGND	CGND	**	**	**	**

\*\* not used

CGND is the chassis ground

02.03.99	AJ	AJ	- -	
Date	S	TZ	Off. in ch.	contr. techn.

**PF**  
PEPPERL+FUCHS  
Mannheim-Schönau

**D-TR-3604E**

Dept.: PA-VP	Nr. <b>36-9285A</b>
vB	Replaces: XXXXX / 36-XXXX
Up date: 07.05.07	Sheet 1
Scale: - : -	of 1

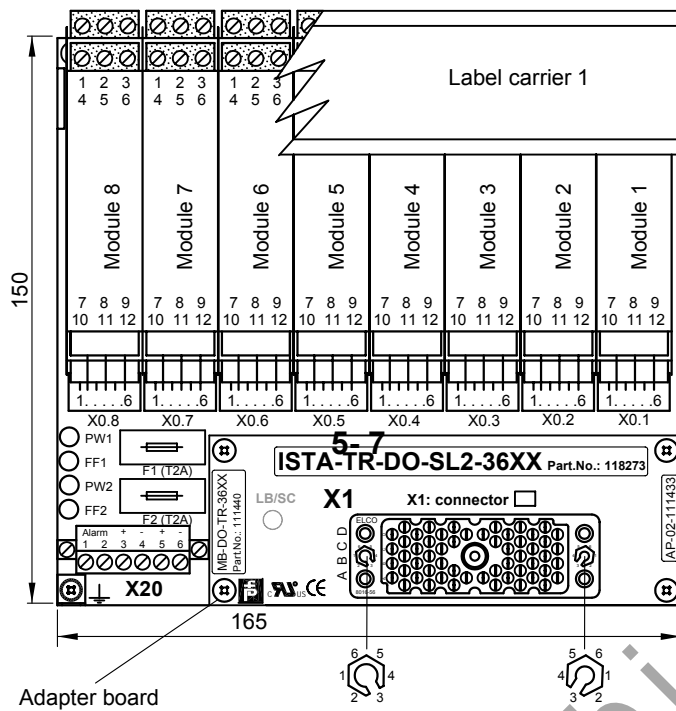

**APPLICATION:**

**TRICONEX I/O card 3604E**  
16 points, non commoned

Motherboard 1: connected with connector #A  
Module 1 ... 8, channels 1 ... 16

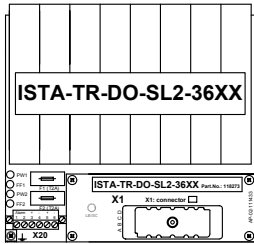

connector #A

**APPLICATION:**

**TRICONEX I/O card 3664:** will be required 2 x ISTA-TR-DO-SL2-36XX-118273  
32 points, non commoned

Motherboard 2: connected with connector #B  
Module 1 ... 8, channels 17 ... 32

Motherboard 1: connected with connector #A  
Module 1 ... 8, channels 1 ... 16

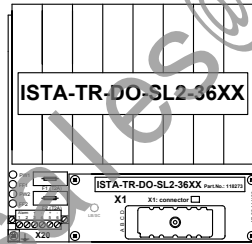

connector #B

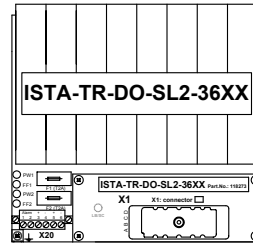

connector #A

Name	Note
X1	56 pin female system connector ELCO (small key: 3, large key: 3)
----	----
X0.1 .... 16	6 pin male terminals for cable tree FSY....
X20.3 .... 6	Power supply screw terminals
X20.1, X20.2	Alarm screw terminal
F1, F2	Fuse
PW1, PW2, FF1, FF2	LEDs for power and power failure

**Ordering information: ISTA-TR-DO-SL2-36XX-118273**

Basic components:	Description
<b>8 pieces:</b> KFD2-SL2-Ex2.B (DO)	KF-Module type (function)
<b>1 piece:</b> MB-DO-TR-36XX-111440	Motherboard without modules
<b>composed by:</b>	
1 piece: MB-8U2-Y97680	Motherboard without modules, adapter board, FSY cable tree and Label carrier
1 piece: AP-02-111433	Adapter board
1 piece: KFD0-LC1-8M-99143	Label carrier 1
8 pieces: FSY-L456-98837	Cable tree connection KF-Module-Motherboard

copyright according to DIN34  
unauthorized distribution and reproduction prohibited

	<b>PEPPERL+FUCHS</b> Mannheim-Schönau	Motherboard unit Digital Output 16 channels <b>ISTA-TR-DO-SL2-36XX</b>	21.03.02	KT	vB	vB/Sb	
			Date	S TZ	Off. in ch.	contr. techn.	contr. Norm
			Dept.: PA-VP	Nr. <b>36-7363B</b>			
Up date: 04.05.07	Replaces: XXXXXX/ 36-XXXX		Sheet 1				
MB-8U2	Scale: 1 : 2 (1 : 5)		of 2				





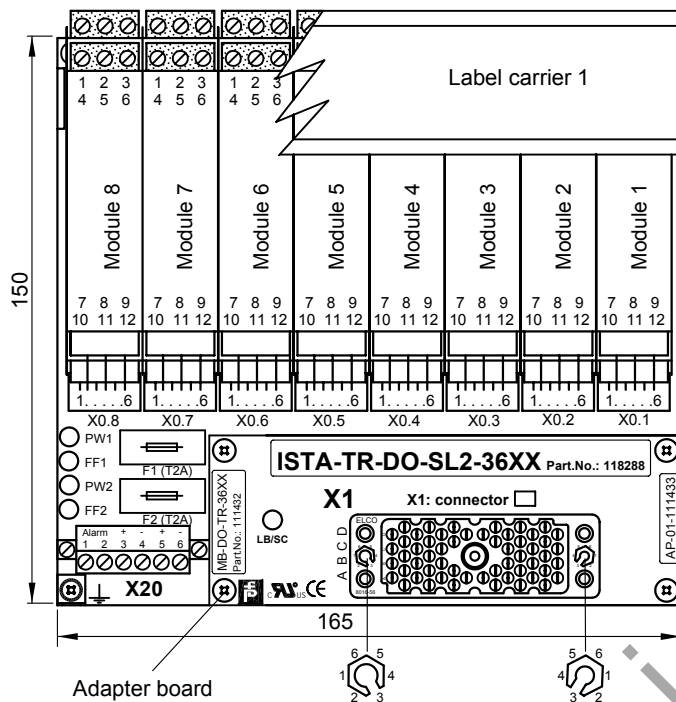

**APPLICATION:**

**TRICONEX I/O card 3604E**  
16 points, non commoned

Motherboard 1: connected with connector #A  
Module 1 ... 8, channels 1 ... 16

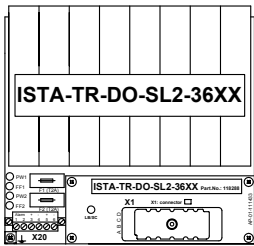

connector #A

**APPLICATION:**

**TRICONEX I/O card 3664: will be required 2 x ISTA-TR-DO-SL2-36XX-118288**  
32 points, non commoned

Motherboard 2: connected with connector #B  
Module 1 ... 8, channels 17 ... 32

Motherboard 1: connected with connector #A  
Module 1 ... 8, channels 1 ... 16

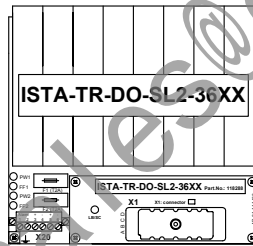

connector #B

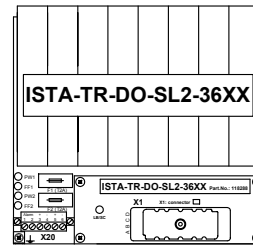

connector #A

Name	Note
X1	56 pin female system connector ELCO (small key: 3, large key: 3)
-----	-----
X0.1 .... 16	6 pin male terminals for cable tree FSY....
X20.3 .... 6	Power supply screw terminals
X20.1, X20.2	Alarm screw terminal
F1, F2	Fuse
PW1, PW2, FF1, FF2	LEDs for power and power failure
Power Rail	PR-03 (with 3 conductors)

**Ordering information: ISTA-TR-DO-SL2-36XX-118288**

Basic components:	Description
<b>8 pieces:</b> KFD2-SL2-Ex2 (DO)	KF-Module type (function)
<b>1 piece:</b> MB-DO-TR-36XX-111432	Motherboard without modules
<b>composed by:</b>	
1 piece: MB-8U2-Y97680	Motherboard without modules, adapter board, FSY cable tree and Label carrier
1 piece: AP-01-111433	Adapter board
1 piece: KFD0-LC1-8M-99143	Label carrier 1
8 pieces: FSY-L456-98837	Cable tree connection KF-Module-Motherboard

copyright according to DIN34 unauthorized distribution and reproduction prohibited

	<b>Motherboard unit</b> Digital Output 16 channels - LB/SC monitoring <b>ISTA-TR-DO-SL2-36XX</b>	21.03.02	KT	vB	vB/Sb		
		Date	S	TZ	Off. in ch.	contr. techn.	contr. Norm
		Dept.: PA-VP	Nr. <b>36-7358A</b>				
		Up date: 04.05.07	Replaces: XXXXXX/ 36-XXXX		Sheet 1		
		MB-8U2	Scale: 1 : 2, 1 : 5		of 2		



## 6. 3664 Application

(16 + 16 channels DO)

	Page
<b>Simplified schematic 3664</b> .....	6- 1
<b>2 x Motherboard ISTA-TR-DO-SD-36XX-118274</b> .....	6- 2
<b>Part No.:</b>	118274
<b>Function:</b>	Digital Output
<b>Channels:</b>	16
<b>System cable:</b>	(ELCO connector)
<b>KF- Module:</b>	KFD2-SD-Ex1.48... (single channel)
<b>Simplified schematic:</b>	drawing no. 36-9286
<b>Wiring Diagram:</b>	drawing no. 36-7430
<b>Simplified schematic 3664</b> .....	6- 5
<b>2 x Motherboard ISTA-TR-DO-SL2-36XX-118273</b> .....	6- 6
<b>Part No.:</b>	118273
<b>Function:</b>	Digital Output
<b>Channels:</b>	16
<b>System cable:</b>	(ELCO connector)
<b>KF- Module:</b>	KFD2-SL2-Ex2.B (dual channel)
<b>Simplified schematic:</b>	drawing no. 36-9287
<b>Wiring Diagram:</b>	drawing no. 36-7363
<b>2 x Motherboard ISTA-TR-DO-SL2-36XX-118288</b> .....	6- 8
<b>Part No.:</b>	118288
<b>Function:</b>	Digital Output
<b>Channels:</b>	16
<b>System cable:</b>	(ELCO connector)
<b>KF- Module:</b>	KFD2-SL2-Ex2 (dual channel)
<b>Simplified schematic:</b>	drawing no. 36-9287
<b>Wiring Diagram:</b>	drawing no. 36-7358

**3664 DIGITAL OUTPUT MODULE**

**Simplified schematic of a typical 32-point commoned dual DC digital output module with self protection (1 of 32 points shown)**

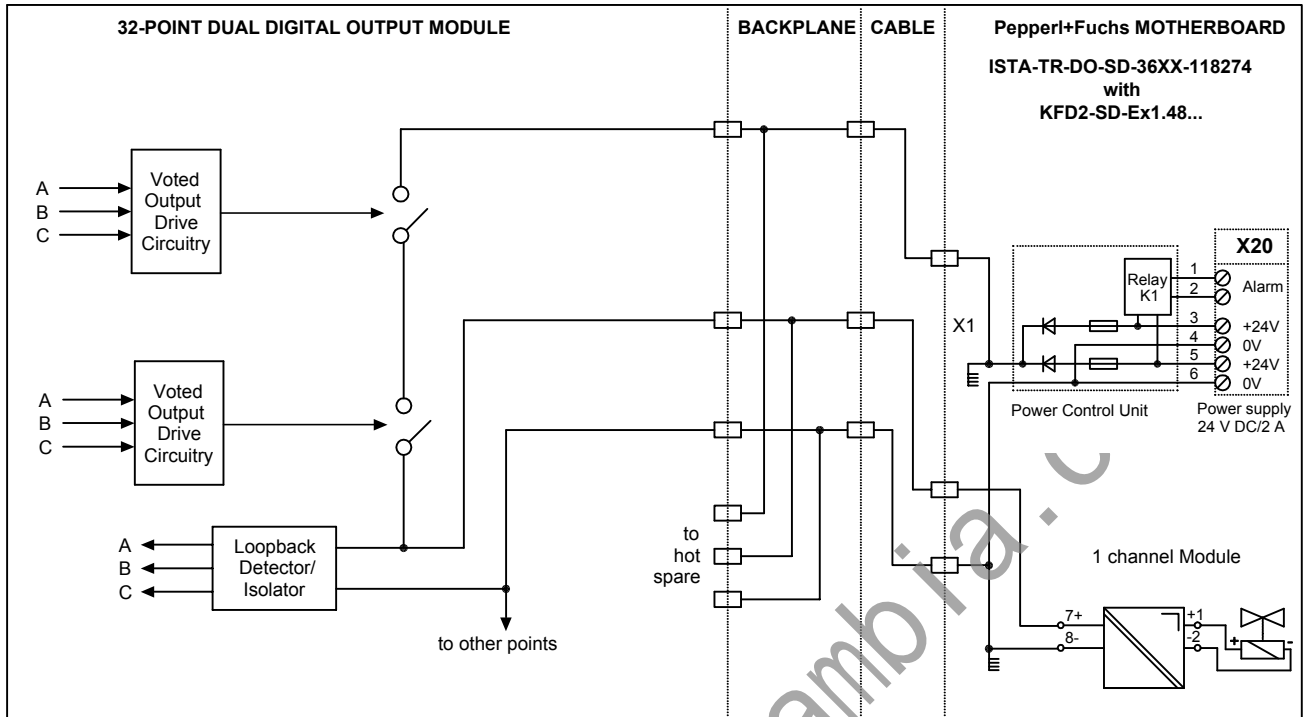

**Pin assignment of connector #A (56 pin ELCO female)**

<b>Pin</b>	AA	KK	LL	z	DD	EE	p	u	v	h	k	l	e	a
<b>Signal</b>	PWR1	LOAD1	RTN1	PWR2	LOAD2	RTN2	PWR3	LOAD3	RTN3	PWR4	LOAD4	RTN4	PWR5	LOAD5
<b>Pin</b>	b	W	R	S	L	E	F	M	A	B	BB	NN	MM	CC
<b>Signal</b>	RTN5	PWR6	LOAD6	RTN6	PWR7	LOAD7	RTN7	PWR8	LOAD8	RTN8	PWR9	LOAD9	RTN9	PWR10
<b>Pin</b>	JJ	HH	t	y	x	j	n	m	f	d	c	Z	V	U
<b>Signal</b>	LOAD10	RTN10	PWR11	LOAD11	RTN11	PWR12	LOAD12	RTN12	PWR13	LOAD13	RTN13	PWR14	LOAD14	RTN14
<b>Pin</b>	P	K	J	N	D	C	T	H	w	FF	r	s	X	Y
<b>Signal</b>	PWR15	LOAD15	RTN15	PWR16	LOAD16	RTN16	CGND	CGND	CGND	CGND	**	**	**	**

**Pin assignment of connector #B (56 pin ELCO female)**

<b>Pin</b>	AA	KK	LL	z	DD	EE	p	u	v	h	k	l	e	a
<b>Signal</b>	PWR17	LOAD17	RTN17	PWR18	LOAD18	RTN18	PWR19	LOAD19	RTN19	PWR20	LOAD20	RTN20	PWR21	LOAD21
<b>Pin</b>	b	W	R	S	L	E	F	M	A	B	BB	NN	MM	CC
<b>Signal</b>	RTN21	PWR22	LOAD22	RTN22	PWR23	LOAD23	RTN23	PWR24	LOAD24	RTN24	PWR25	LOAD25	RTN25	PWR26
<b>Pin</b>	JJ	HH	t	y	x	j	n	m	f	d	c	Z	V	U
<b>Signal</b>	LOAD26	RTN26	PWR27	LOAD27	RTN27	PWR28	LOAD28	RTN28	PWR29	LOAD29	RTN29	PWR30	LOAD30	RTN30
<b>Pin</b>	P	K	J	N	D	C	T	H	w	FF	r	s	X	Y
<b>Signal</b>	PWR31	LOAD31	RTN31	PWR32	LOAD32	RTN32	CGND	CGND	CGND	CGND	**	**	**	**

\*\* not used

CGND is the chassis ground

21.07.99	AJ	AJ	--	
Date	S	TZ	Off. in ch.	contr. techn.
			contr.	Norm



**D-TR-3664**

Dept.: PA-VP	<b>Nr. 36-9286</b>
vB/Bro	Replaces:
Up date: 23.03.04	XXXXX / 36-XXXX
Scale: - : -	Sheet 1 of 1

copyright according to DIN34  
unauthorized distribution and reproduction prohibited

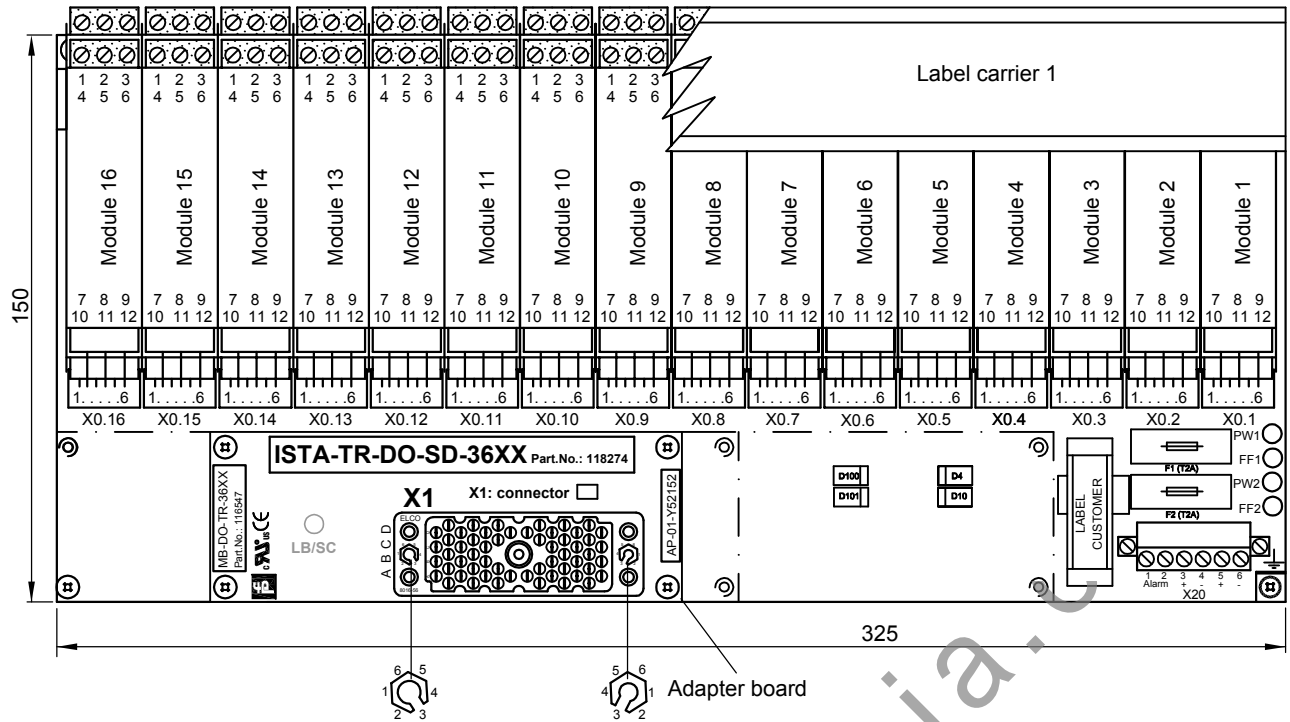

**APPLICATION:**  
**TRICONEX I/O card 3604E:**  
 16 points, non commoned

Motherboard 1: connected with connector #A  
 Module 1 ... 16, channels 1 ... 16

**APPLICATION:**  
**TRICONEX I/O card 3664:** will be required 2 x ISTA-TR-DO-SD-36XX-118274  
 16 + 16 points, non commoned, diff., DC coupled

Motherboard 2: connected with connector #B  
 Module 1 ... 16, channels 1 ... 16

Motherboard 1: connected with connector #A  
 Module 1 ... 16, channels 1 ... 16

Name	Note
X1	56 pin female system connector ELCO (small key: 3, large key: 3)
----	----
X0.1 .... 16	6 pin male terminals for cable tree FSY....
X20.3 .... 6	Power supply screw terminals
X20.1, X20.2	Alarm screw terminal
F1, F2	Fuse
PW1, PW2, FF1, FF2	LEDs for power and power failure

Ordering information: ISTA-TR-DO-SD-36XX-118274		
Basic components:	Description	
<b>16 pieces:</b>	<b>KFD2-SD-Ex1.48... (DO)</b>	KF-Module type (function)
<b>1 piece:</b>	<b>MB-DO-TR-36XX-116547</b>	Motherboard without modules
<b>composed by:</b>		
1 piece:	MB-16U5L-103681	Motherboard without modules, adapter board, FSY cable tree and Label carrier
1 piece:	AP-01-Y52152	Adapter board
1 piece:	KFD0-LC1-16M-99144	Label carrier 1
16 pieces:	FSY-L450-98833	Cable tree connection KF-Module-Motherboard

copyright according to DIN34 unauthorized distribution and reproduction prohibited

	<b>PEPPERL+FUCHS</b> <b>Mannheim-Schönau</b>	Motherboard unit Digital Output <b>16 channels</b> <b>ISTA-TR-DO-SD-36XX</b>	21.03.02	KT	vB	vB/Sb		
			Date	S	TZ	Off. in ch.	contr. techn.	contr. Norm
			Dept.: PA-VP	Nr. <b>36-7430</b>				
			Up date: 22.03.04	Replaces: 116547 / 36-7621			Sheet 1	
		MB-16U5L	Scale: 1 : 2 (1 : 8)	of 3				

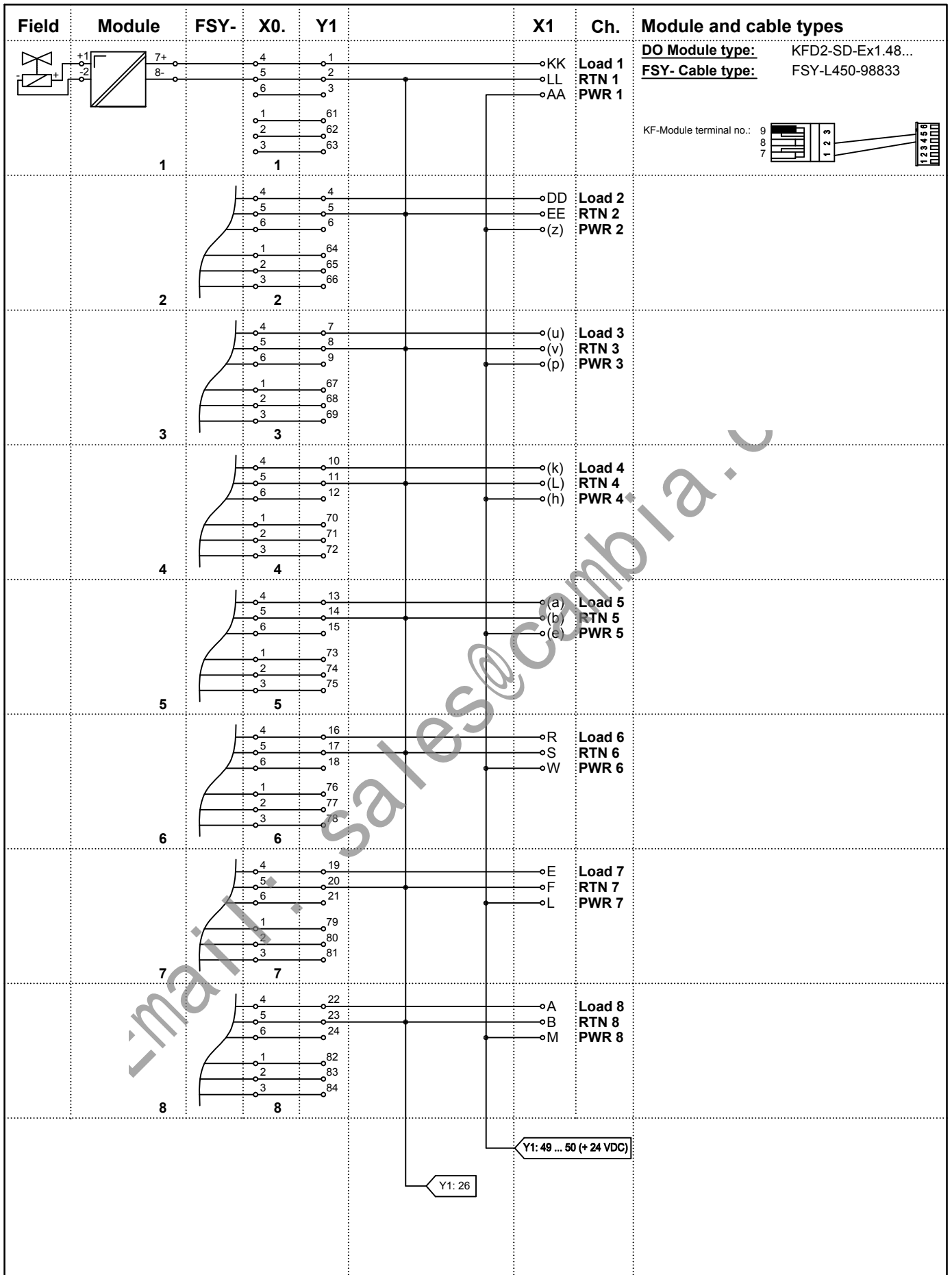

copyright according to DIN34  
 unauthorized distribution and reproduction prohibited

	Note: Letters in brackets are small letters				
	21.03.02		KT	vB	vB/Sb
	Date	S	TZ	Off. in ch.	contr. techn.
	Dept.: PA-VP Up date: 22.03.04		Nr. <b>36-7430</b> Replaces: 116547 / 36-7621		
MB-16U5L		Scale:		Sheet 2 of 3	

copyright according to DIN34  
 unauthorized distribution and reproduction prohibited

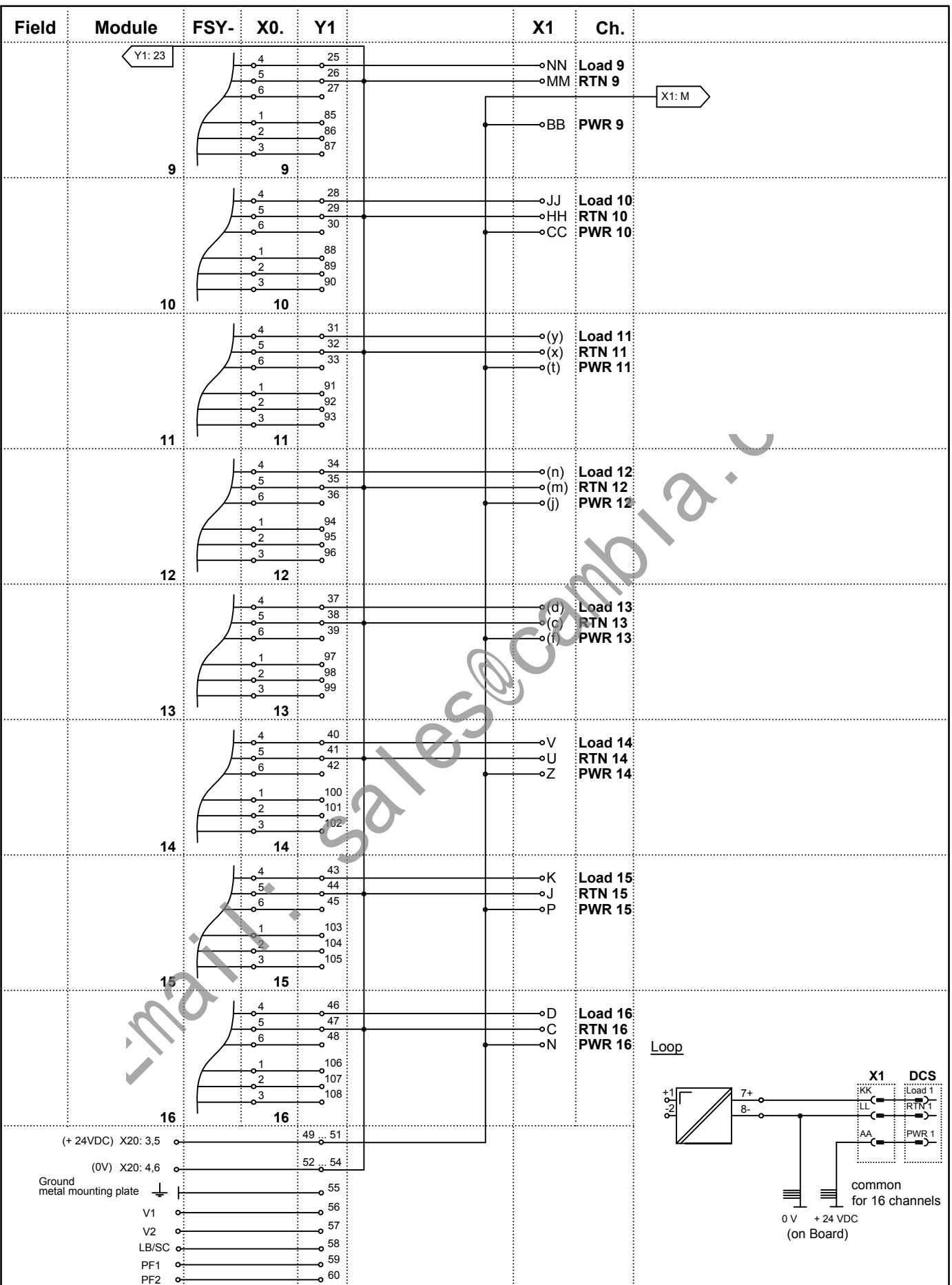

Note: Letters in brackets are small letters



Motherboard unit  
 Digital Output  
 16 channels  
 ISTA-TR-DO-SD-36XX

21.03.02		KT	vB	vB/Sb	
Date	S	TZ	Off. in ch.	contr. techn.	contr. Norm
Dept.: PA-VP		Nr. <b>36-7430</b>			
Up date: vB/Bro 22.03.04		Replaces: 116547 / 36-7621		Sheet 3	
MB-16U5L		Scale:		of 3	



**3664 DIGITAL OUTPUT MODULE**

**Simplified schematic of a typical 32-point commoned dual DC digital output module with self protection (1 of 32 points shown)**

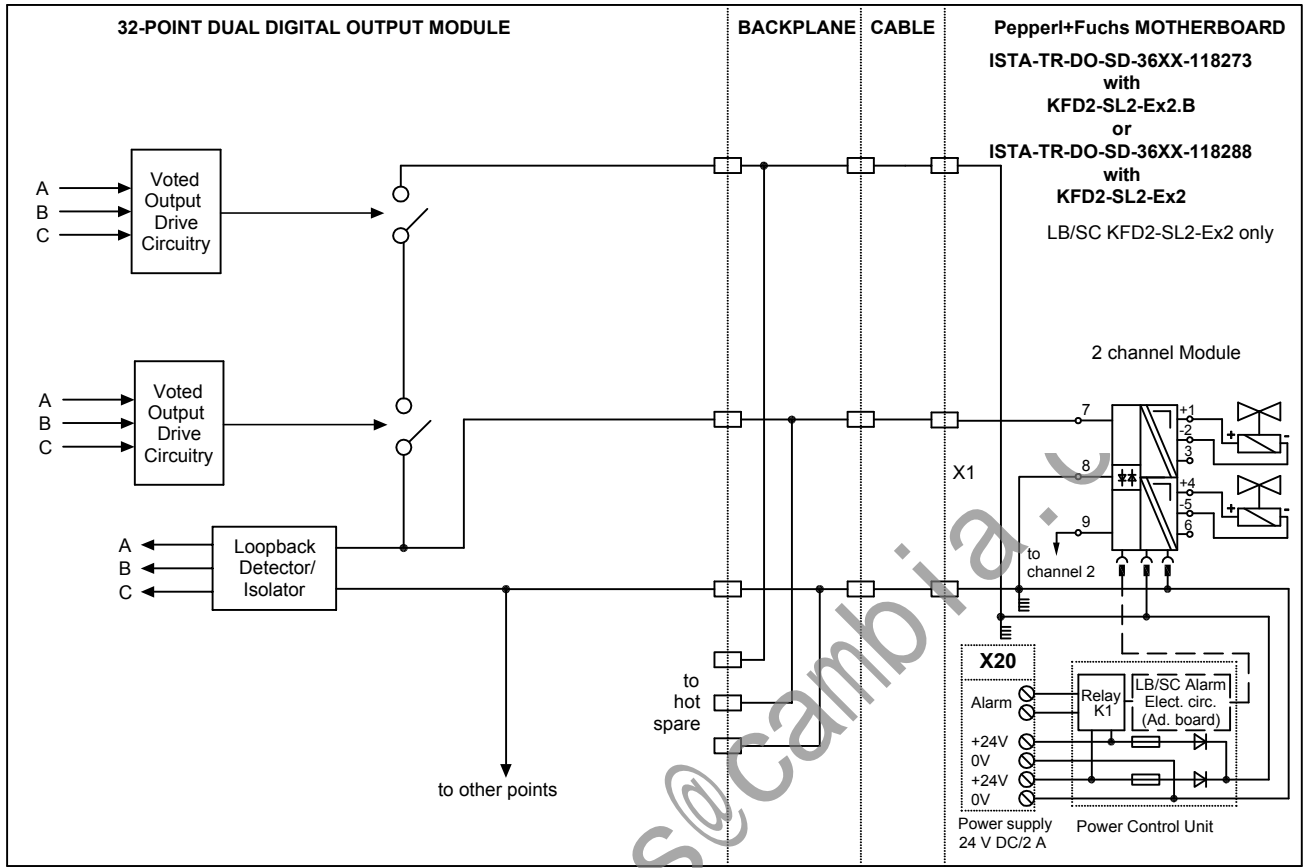

**Pin assignment of connector #A (56 pin ELCO female)**

Pin	AA	KK	LL	z	DD	EE	p	u	v	h	k	l	e	a
Signal	PWR1	LOAD1	RTN1	PWR2	LOAD2	RTN2	PWR3	LOAD3	RTN3	PWR4	LOAD4	RTN4	PWR5	LOAD5
Pin	b	W	R	S	L	E	F	M	A	B	BB	NN	MM	CC
Signal	RTN5	PWR6	LOAD6	RTN6	PWR7	LOAD7	RTN7	PWR8	LOAD8	RTN8	PWR9	LOAD9	RTN9	PWR10
Pin	JJ	HH	t	y	x	j	n	m	f	d	c	Z	V	U
Signal	LOAD10	RTN10	PWR11	LOAD11	RTN11	PWR12	LOAD12	RTN12	PWR13	LOAD13	RTN13	PWR14	LOAD14	RTN14
Pin	P	K	J	N	D	C	T	H	w	FF	r	s	X	Y
Signal	PWR15	LOAD15	RTN15	PWR16	LOAD16	RTN16	CGND	CGND	CGND	CGND	**	**	**	**

**Pin assignment of connector #B (56 pin ELCO female)**

Pin	AA	KK	LL	z	DD	EE	p	u	v	h	k	l	e	a
Signal	PWR17	LOAD17	RTN17	PWR18	LOAD18	RTN18	PWR19	LOAD19	RTN19	PWR20	LOAD20	RTN20	PWR21	LOAD21
Pin	b	W	R	S	L	E	F	M	A	B	BB	NN	MM	CC
Signal	RTN21	PWR22	LOAD22	RTN22	PWR23	LOAD23	RTN23	PWR24	LOAD24	RTN24	PWR25	LOAD25	RTN25	PWR26
Pin	JJ	HH	t	y	x	j	n	m	f	d	c	Z	V	U
Signal	LOAD26	RTN26	PWR27	LOAD27	RTN27	PWR28	LOAD28	RTN28	PWR29	LOAD29	RTN29	PWR30	LOAD30	RTN30
Pin	P	K	J	N	D	C	T	H	w	FF	r	s	X	Y
Signal	PWR31	LOAD31	RTN31	PWR32	LOAD32	RTN32	CGND	CGND	CGND	CGND	**	**	**	**

\*\* not used

CGND is the chassis ground

21.07.99		AJ	AJ	--	
Date	S	TZ	Off. in ch.	contr. techn.	contr. Norm



**D-TR-3664**

Dept.: PA-VP	<b>Nr. 36-9287</b>
vB/Bro	Replaces: XXXXX / 36-XXXX
Up date: 23.03.04	Sheet 1
Scale: - : -	of 1

copyright according to DIN34  
unauthorized distribution and reproduction prohibited

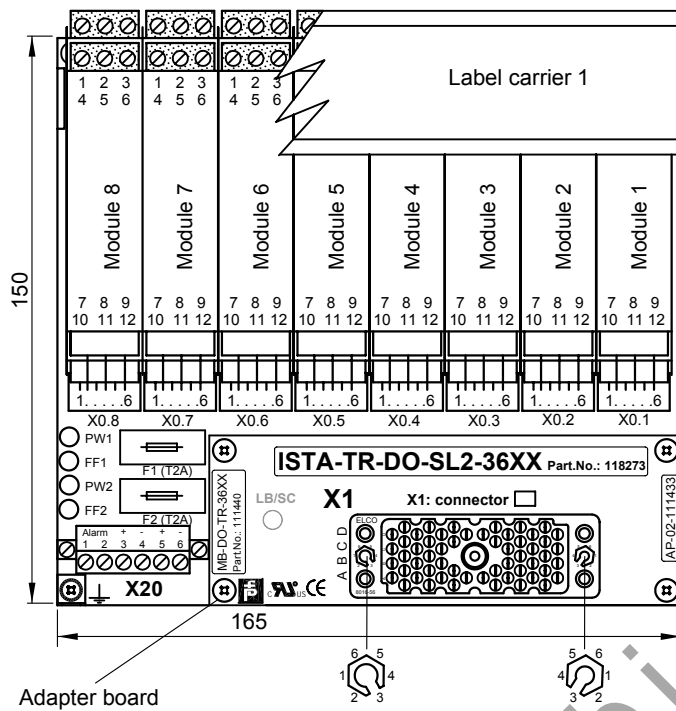

**APPLICATION:**

**TRICONEX I/O card 3604E**  
16 points, non commoned

Motherboard 1: connected with connector #A  
Module 1 ... 8, channels 1 ... 16

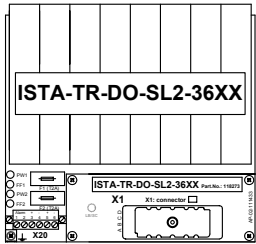

connector #A

**APPLICATION:**

**TRICONEX I/O card 3664:** will be required 2 x ISTA-TR-DO-SL2-36XX-118273  
32 points, non commoned

Motherboard 2: connected with connector #B  
Module 1 ... 8, channels 17 ... 32  
Motherboard 1: connected with connector #A  
Module 1 ... 8, channels 1 ... 16

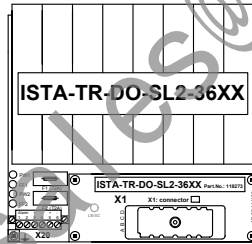

connector #B

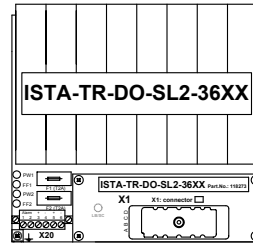

connector #A

Name	Note
X1	56 pin female system connector ELCO (small key: 3, large key: 3)
----	----
X0.1 .... 16	6 pin male terminals for cable tree FSY....
X20.3 .... 6	Power supply screw terminals
X20.1, X20.2	Alarm screw terminal
F1, F2	Fuse
PW1, PW2, FF1, FF2	LEDs for power and power failure

**Ordering information: ISTA-TR-DO-SL2-36XX-118273**

Basic components:	Description
<b>8 pieces:</b> KFD2-SL2-Ex2.B (DO)	KF-Module type (function)
<b>1 piece:</b> MB-DO-TR-36XX-111440	Motherboard without modules
<b>composed by:</b>	
1 piece: MB-8U2-Y97680	Motherboard without modules, adapter board, FSY cable tree and Label carrier
1 piece: AP-02-111433	Adapter board
1 piece: KFD0-LC1-8M-99143	Label carrier 1
8 pieces: FSY-L456-98837	Cable tree connection KF-Module-Motherboard

copyright according to DIN34  
unauthorized distribution and reproduction prohibited

	<b>PEPPERL+FUCHS</b> Mannheim-Schönau	Motherboard unit Digital Output 16 channels <b>ISTA-TR-DO-SL2-36XX</b>	21.03.02	KT	vB	vB/Sb	
			Date	S TZ	Off. in ch.	contr. techn.	contr. Norm
			Dept.: PA-VP	<b>Nr. 36-7363B</b>			
Up date: 04.05.07	Replaces: XXXXXX/ 36-XXXX		Sheet 1				
MB-8U2	Scale: 1 : 2 (1 : 5)		of 2				

copyright according to DIN34  
unauthorized distribution and reproduction prohibited

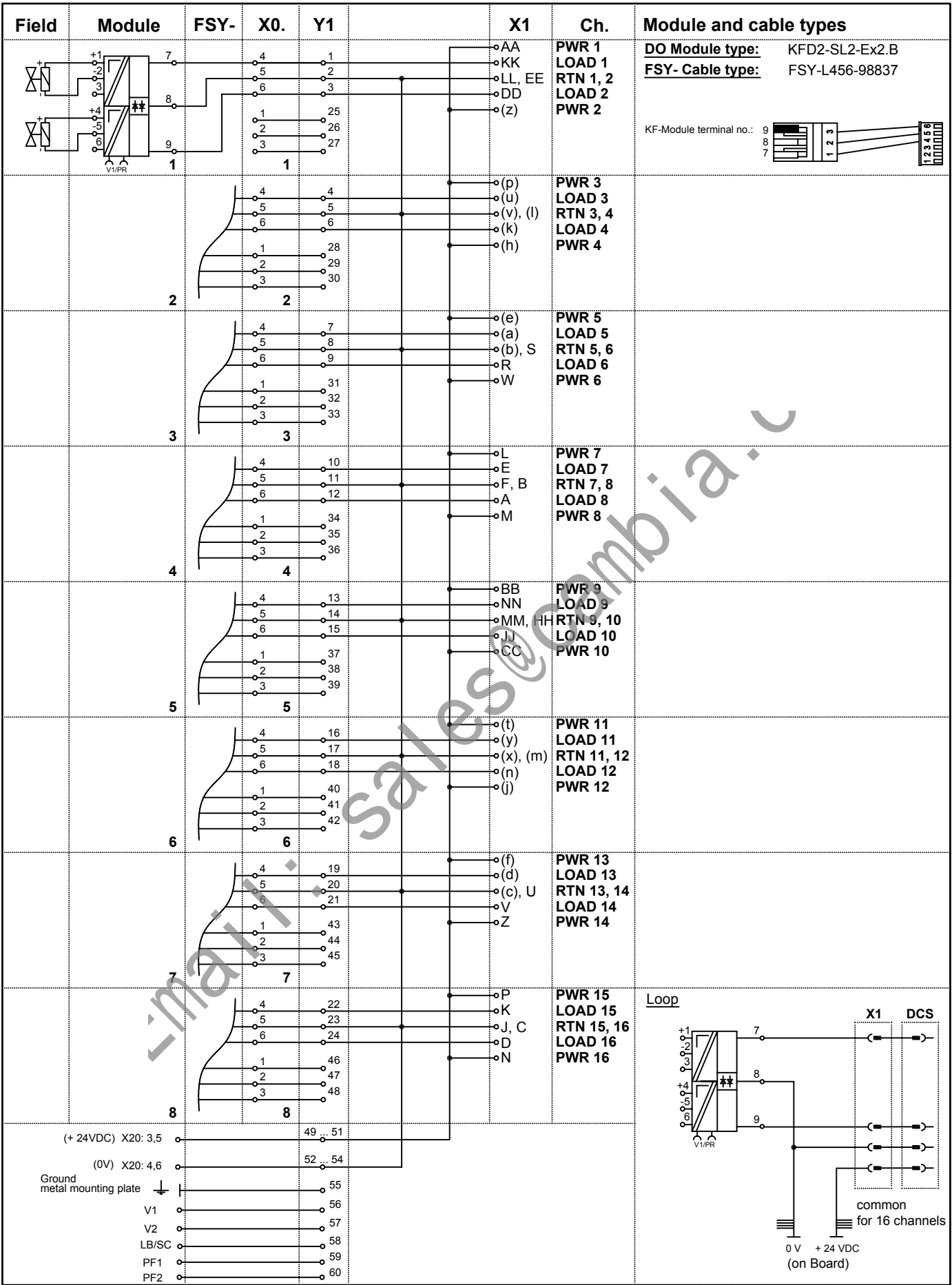

Note: Letters in brackets are small letters

**PEPPERL+FUCHS**  
Mannheim-Schönau

Motherboard unit  
Digital Output  
16 channels  
**ISTA-TR-DO-SL2-36XX**

21.03.02		KT	vB	vB/Sb	
Date	S	TZ	Off. in ch.	contr. techn.	contr. Norm
Dept.: PA-007	vB		<b>Nr. 36-7363B</b>		
Up date:	Replaces: XXXXXX/ 36-XXXX		Sheet 2		
MB-8U2	Scale: - : -		of 2		

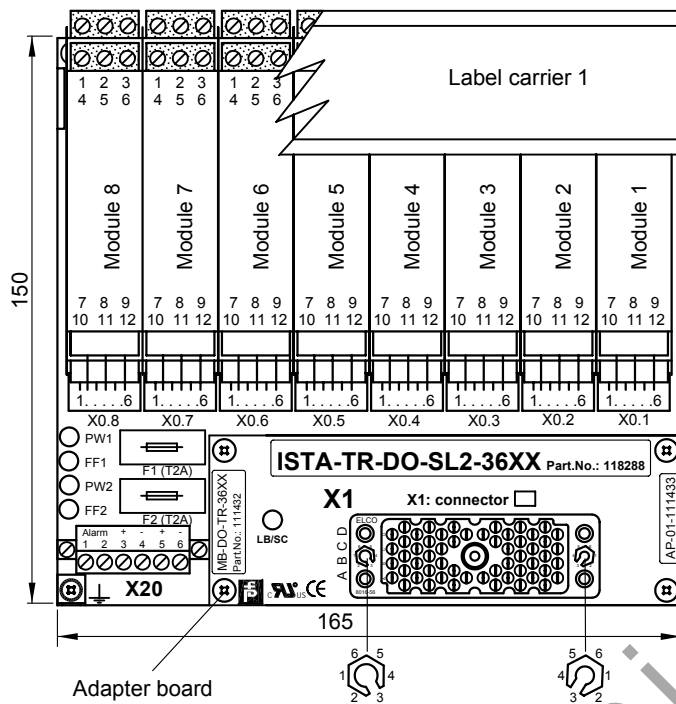

**APPLICATION:**

**TRICONEX I/O card 3604E**  
16 points, non commoned

Motherboard 1: connected with connector #A  
Module 1 ... 8, channels 1 ... 16

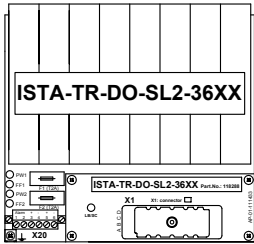

connector #A

**APPLICATION:**

**TRICONEX I/O card 3664: will be required 2 x ISTA-TR-DO-SL2-36XX-118288**  
32 points, non commoned

Motherboard 2: connected with connector #B  
Module 1 ... 8, channels 17 ... 32

Motherboard 1: connected with connector #A  
Module 1 ... 8, channels 1 ... 16

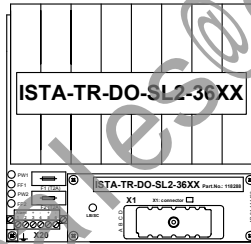

connector #B

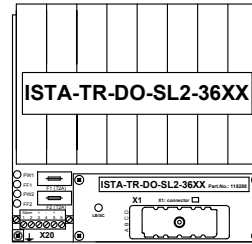

connector #A

Name	Note
X1	56 pin female system connector ELCO (small key: 3, large key: 3)
-----	-----
X0.1 .... 16	6 pin male terminals for cable tree FSY....
X20.3 .... 6	Power supply screw terminals
X20.1, X20.2	Alarm screw terminal
F1, F2	Fuse
PW1, PW2, FF1, FF2	LEDs for power and power failure
Power Rail	PR-03 (with 3 conductors)

**Ordering information: ISTA-TR-DO-SL2-36XX-118288**

Basic components:	Description
<b>8 pieces:</b>	<b>KFD2-SL2-Ex2 (DO)</b> KF-Module type (function)
<b>1 piece:</b>	<b>MB-DO-TR-36XX-111432</b> Motherboard without modules
<b>composed by:</b>	
1 piece:	MB-8U2-Y97680 Motherboard without modules, adapter board, FSY cable tree and Label carrier
1 piece:	AP-01-111433 Adapter board
1 piece:	KFD0-LC1-8M-99143 Label carrier 1
8 pieces:	FSY-L456-98837 Cable tree connection KF-Module-Motherboard

copyright according to DIN34  
unauthorized distribution and reproduction prohibited

	<b>Motherboard unit</b> Digital Output 16 channels - LB/SC monitoring <b>ISTA-TR-DO-SL2-36XX</b>	21.03.02	KT	vB	vB/Sb	
		Date	S TZ	Off. in ch.	contr. techn.	contr. Norm
		Dept.: PA-VP	Nr. <b>36-7358A</b>			
		Up date: 04.05.07	Replaces: XXXXXX/ 36-XXXX		Sheet 1	
		MB-8U2	Scale: 1 : 2, 1 : 5		of 2	

copyright according to DIN34  
unauthorized distribution and reproduction prohibited

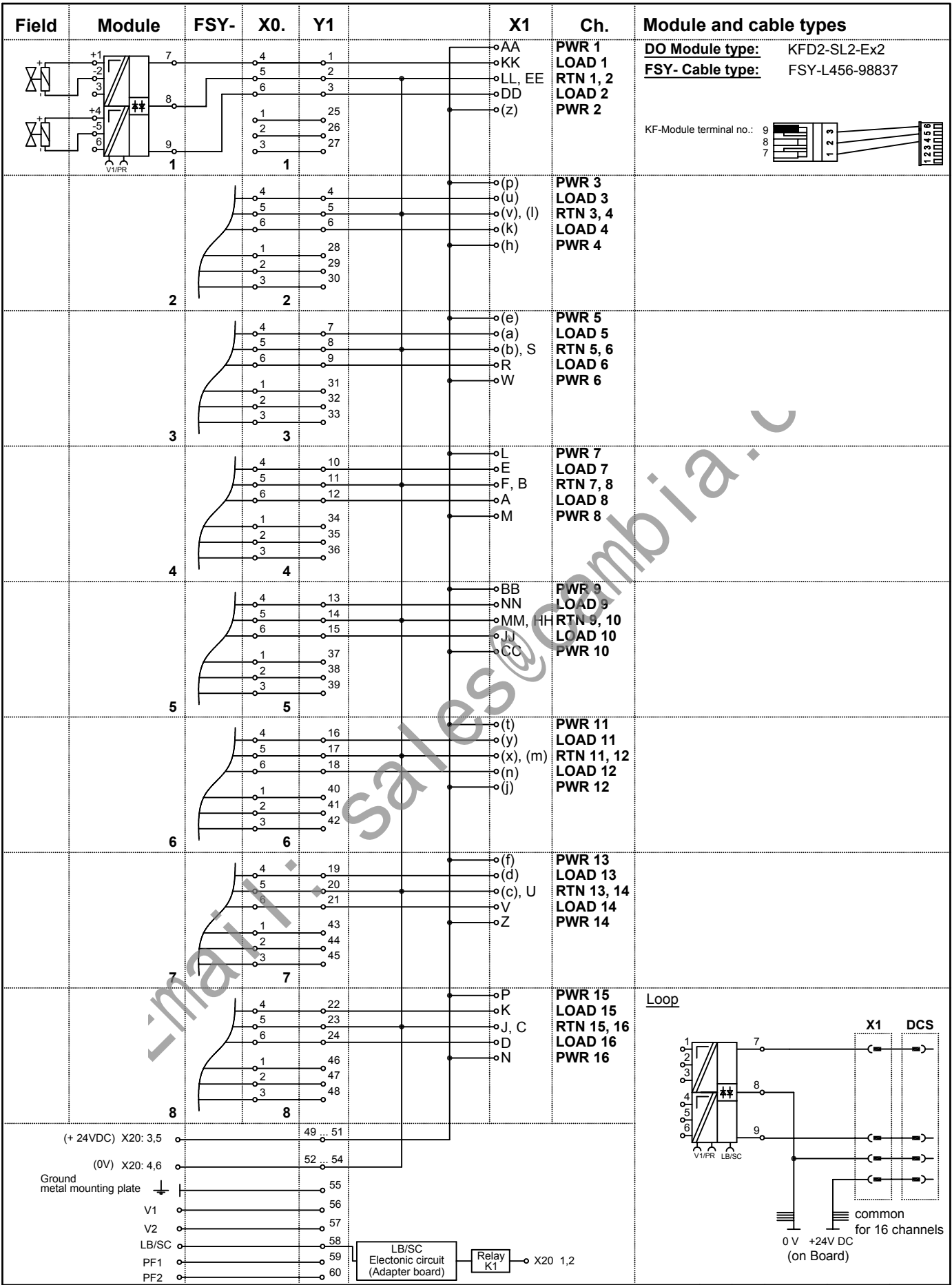

Note: Letters in brackets are small letters

**PEPPERL+FUCHS**  
Mannheim-Schönau

Motherboard unit  
Digital Output  
16 channels - LB/SC monitoring  
**ISTA-TR-DO-SL2-36XX**

21.03.02		KT	vB	vB/Sb	
Date	S	TZ	Off. in ch.	contr. techn.	contr. Norm
Dept.: PA-VP	vB		<b>Nr. 36-7358A</b>		
Up date: 04.05.07	Replaces: XXXXXX/ 36-XXXX		Sheet 2		
MB-8U2	Scale: - : -		of 2		

## 7. 3703E Application

(16 channels AI)

	Page
<b>Simplified schematic 3703E</b> .....	7- 1
<b>Motherboard ISTA-TR-AI-STC-370X-118275</b> .....	7- 3
<b>Part No.:</b>	118275
<b>Function:</b>	Analog Input + HART
<b>Channels:</b>	16
<b>System cable:</b>	(ELCO connector)
<b>KF- Module:</b>	KFD2-STC4-Ex1 (single channel)
<b>Simplified schematic:</b>	drawing no. 36-9288
<b>Wiring Diagram:</b>	drawing no. 36-7463
<b>Motherboard ISTA-TR-AI-UT-370X-118276</b> .....	7- 6
<b>Part No.:</b>	118276
<b>Function:</b>	Analog Input + HART
<b>Channels:</b>	16
<b>System cable:</b>	(ELCO connector)
<b>KF- Module:</b>	KFD2-UT-Ex1 (single channel)
<b>Simplified schematic:</b>	drawing no. 36-9288
<b>Wiring Diagram:</b>	drawing no. 36-7175

# 3703E ANALOG INPUT MODULE

Simplified schematic of a typical 16-point analog input module  
(1 of 16 points shown)

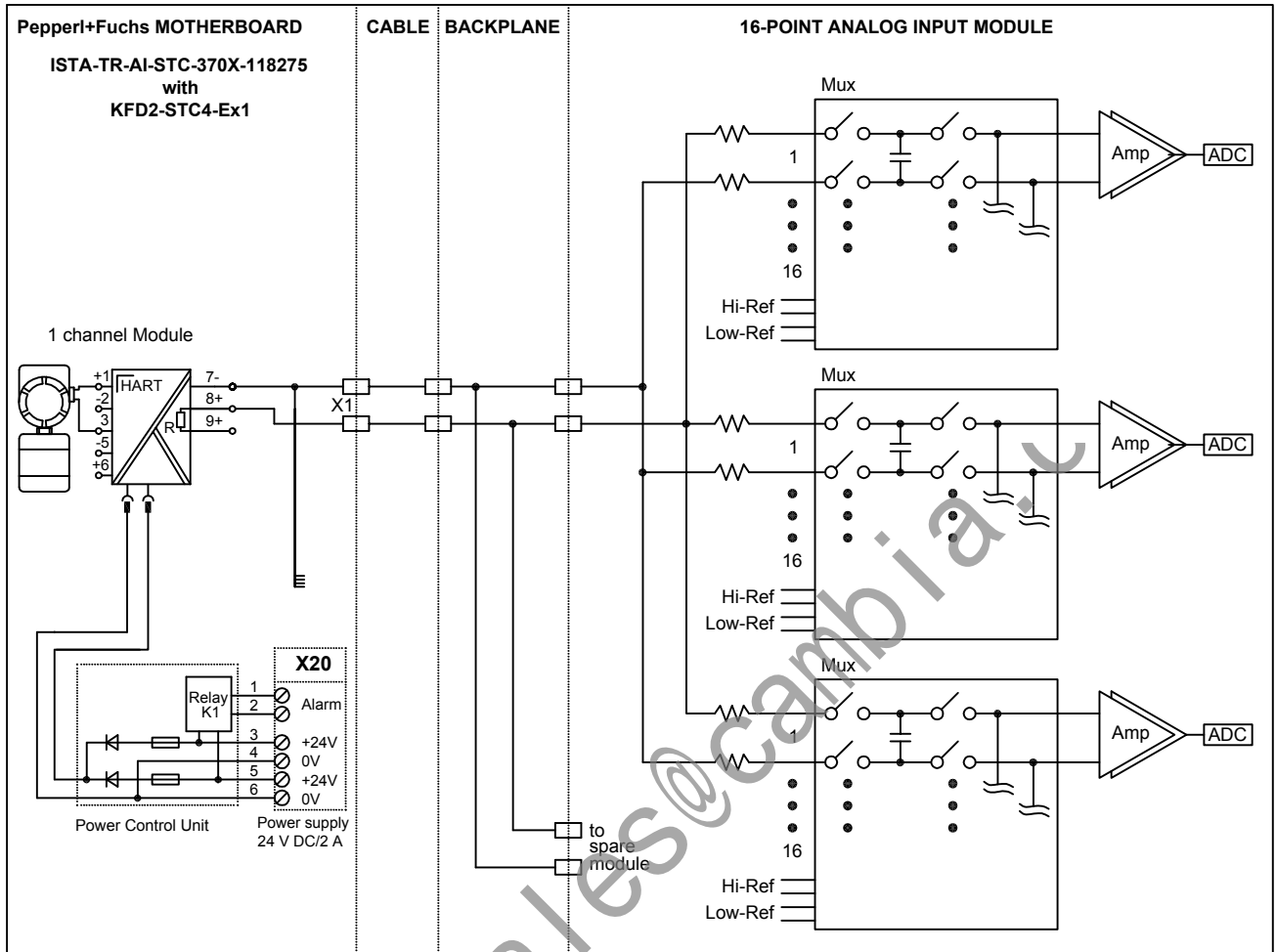

## Pin assignment of connector #A (56 pin ELCO female)

Pin	AA	KK	LL	z	DD	EE	p	u	v	h	k	l	e	a
Signal	IN1+	*	IN1-	IN2+	*	IN2-	IN3+	*	IN3-	IN4+	*	IN4-	IN5+	*
Pin	b	W	R	S	L	E	F	M	A	B	BB	NN	MM	CC
Signal	IN5-	IN6+	*	IN6-	IN7+		IN7-	IN8+		IN8-	IN9+		IN9-	IN10+
Pin	JJ	HH	t	y	x	j	n	m	f	d	c	Z	V	U
Signal		IN10-	IN11+		IN11-	IN12+		IN12-	IN13+		IN13-	IN14+		IN14-
Pin	P	K	J	N	D	C	T	H	w	FF	r	s	X	Y
Signal	IN15+		IN15-	IN16+		IN16-	CGND	CGND	CGND	CGND	**	**	**	**

\* Reserved for internal use. Do not connect for any purpose.

\*\* not used

CGND is the chassis ground

02.03.99		AJ	AJ	--	
Date	S	TZ	Off. in ch.	contr. techn.	contr. Norm
Dept.:	PA-VP		Nr. <b>36-9288</b>		
Up date:	vB/Bro 23.03.04		Replaces: XXXXX / 36-XXXX		Sheet 1
Scale:			- : - of 2		



PEPPERL+FUCHS  
Mannheim-Schönau

D-TR-3703E

# 3703E ANALOG INPUT MODULE

Simplified schematic of a typical 16-point analog input module  
(1 of 16 points shown)

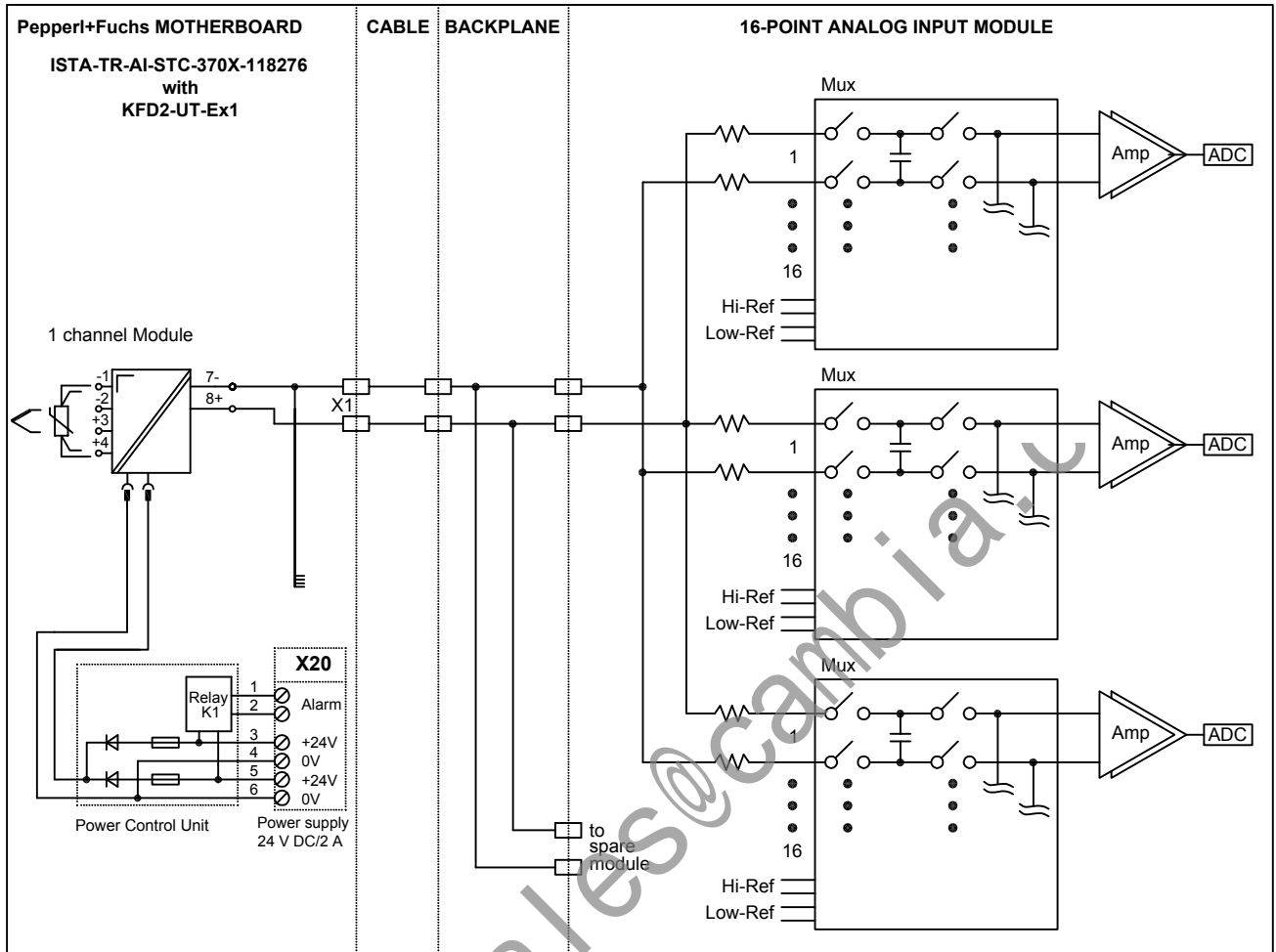

## Pin assignment of connector #A (56 pin ELCO female)

Pin	AA	KK	LL	z	DD	EE	p	u	v	h	k	l	e	a
Signal	IN1+	*	IN1-	IN2+	*	IN2-	IN3+	*	IN3-	IN4+	*	IN4-	IN5+	*
Pin	b	W	R	S	L	E	F	M	A	B	BB	NN	MM	CC
Signal	IN5-	IN6+	*	IN6-	IN7+		IN7-	IN8+		IN8-	IN9+		IN9-	IN10+
Pin	JJ	HH	t	y	x	j	n	m	f	d	c	Z	V	U
Signal		IN10-	IN11+		IN11-	IN12+		IN12-	IN13+		IN13-	IN14+		IN14-
Pin	P	K	J	N	D	C	T	H	w	FF	r	s	X	Y
Signal	IN15+		IN15-	IN16+		IN16-	CGND	CGND	CGND	CGND	**	**	**	**

\* Reserved for internal use. Do not connect for any purpose.

\*\* not used

CGND is the chassis ground

12.05.03		KT	Sb	Sb	
Date	S	TZ	Off. in ch.	contr. techn.	contr. Norm
Dept.:	PA-VP	Nr. <b>36-9288</b>			
Up date:	vB/Bro 23.03.04	Replaces: XXXXX / 36-XXXX			Sheet 2
Scale:			- : -	of 2	



PEPPERL+FUCHS  
Mannheim-Schönau

D-TR-3703E



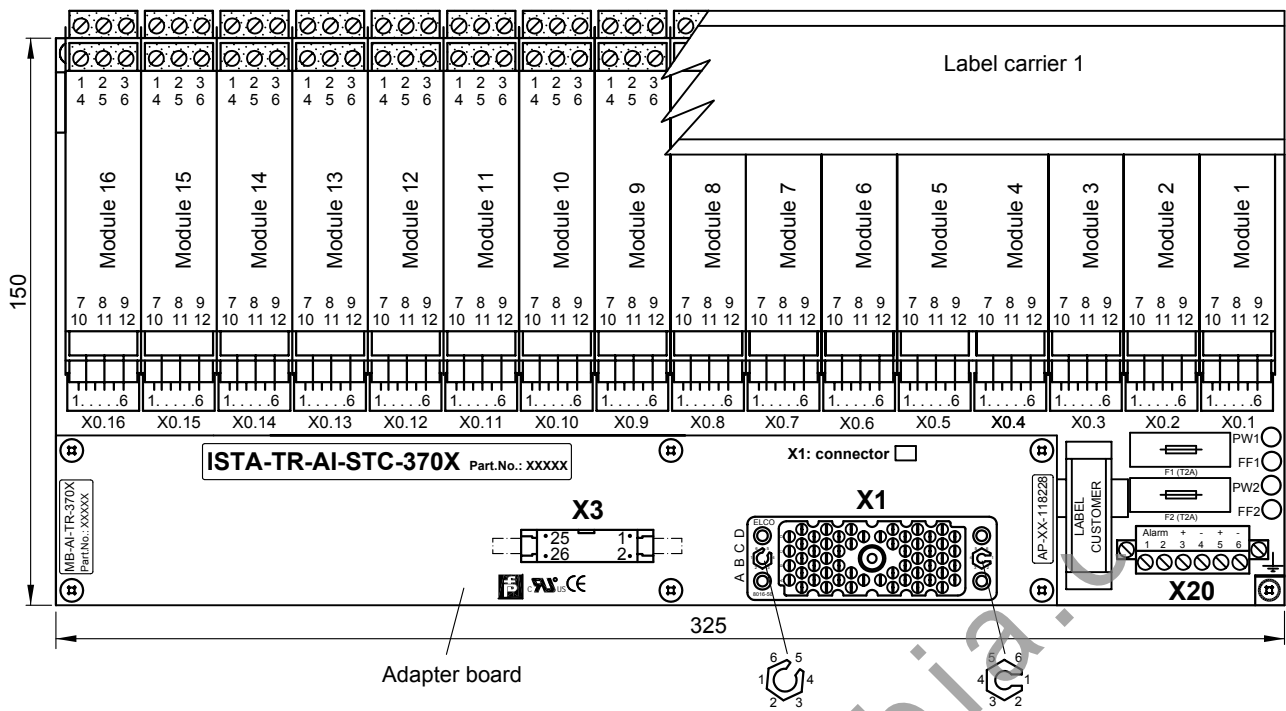

**APPLICATION:**

**TRICONEX I/O card 3703E**  
16 points, non commoned, diff., DC coupled

Module 1 ... 16, channels 1 ... 16

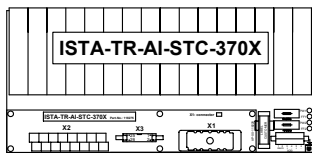

**APPLICATION:**

**TRICONEX I/O card 3700 / 3700A / 3701 (2 x ISTA-TR-AI-STC-370X-XXXXX)**  
16 + 16 points, non commoned, diff., DC coupled

Motherboard: connected with connector #B  
Module 1 ... 16, channels 1 ... 16

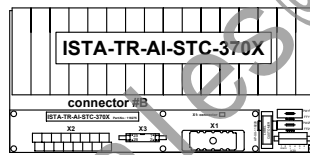

Motherboard: connected with connector #A  
Module 1 ... 16, channels 1 ... 16

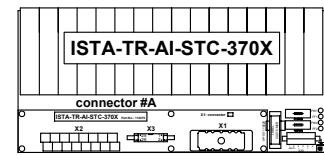

Name	Note
X1	56 pin female system connector ELCO (small key: 1, large key: 5)
X3	26 pin HART connector male
X0.1 ... 16	6 pin male terminals for cable tree FSY....
X20.3 ... 6	Power supply screw terminals
X20.1, X20.2	Alarm screw terminal
F1, F2	Fuse
PW1, PW2, FF1, FF2	LEDs for power and power failure

Ordering information:	ISTA-TR-AI-STC-370X-118275	ISTA-TR-AI-STC-370X-190081	Description
<b>Basic components:</b>			
<b>16 pieces:</b>	<b>KFD2-STC4-Ex1 (AI)</b>	<b>KFD2-STC4-1 (AI)</b>	KF-Module type (function)
<b>1 piece:</b>	<b>MB-AI-TR-370X-118261</b>	<b>MB-AI-TR-370X-190082</b>	Motherboard without modules
<b>composed by:</b>			
1 piece:	MB-16U5L-103681	MB-16U5L-103681	Basis Motherboard (*)
1 piece:	AP-11-118228	AP-12-118228	Adapter board
1 piece:	KFD0-LC1-16M-99144	KFD0-LC1-16M-99144	Label carrier 1
16 pieces:	FSY-L450-98833	FSY-L450-98833	FSY-Cable tree
(*) Basis Motherboard without modules, adapter board and FSY cable tree (connection between Motherboard and Modules)			

**Note:**

For application with module type KFD2-UT-EX1 see part nr. 118276 and 127703 drawing nr. 36-7175

21.03.02		KT	vB	Sb/vB	
Date	S	TZ	Off. in ch.	contr. techn.	contr. Norm
Dept.: PA-VP				<b>Nr. 36-7463i</b>	
Up date: 12.06.08				Replaces: 127672-127676 (36-7560)	Sheet 1
MB-16U5L				Scale: 1 : 2, 1 : 8	of 3



**PEPPERL+FUCHS**  
Mannheim-Schönau

Motherboard unit  
Analog Input - HART  
16 channels  
**ISTA-TR-AI-STC-370X**



Field	Module	FSY-	X0.	Y1		X1	Ch.
	9		9	25 26 27 85 86 87	R9	MM BB 16	IN9- IN9+ Y1: 22
	10		10	28 29 30 88 89 90	R10	HH CC 17	IN10- IN10+
	11		11	31 32 33 91 92 93	R11	(x) (t) 18	IN11- IN11+
	12		12	34 35 36 94 95 96	R12	(m) (j) 19	IN12- IN12+
	13		13	37 38 39 97 98 99	R13	(c) (f) 20	IN13- IN13+
	14		14	40 41 42 100 101 102	R14	U Z 21	IN14- IN14+
	15		15	43 44 45 103 104 105	R15	J P 22	IN15- IN15+
	16		16	46 47 48 106 107 108	R16	C N 23	IN16- IN16+
				49 ... 51 52 ... 54 55 56 57 58 59 60		1 ... 5 14, 15 24 ... 26	
				(+ 24VDC) X20: 3,5 (0V) X20: 4,6 Ground metal mounting plate V1 V2 LB/SC PF1 PF2			

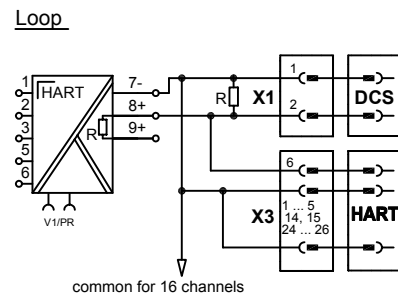

R= 250 ohm resistors 0.01%  
 Note: Letters in brackets are small letters

22.03.02		KT	vB	Sb/vB	
Date	S	TZ	Off. in ch.	contr. techn.	contr. Norm
Dept.: PA-VP	vB		Nr. <b>36-7463i</b>		
Up date: 12.06.08	Replaces: 127672-127676 (36-7560)		Sheet 3		
MB-16U5L	Scale: - - -		of 3		

Motherboard unit  
 Analog Input - HART  
 16 channels  
**ISTA-TR-AI-STC-370X**

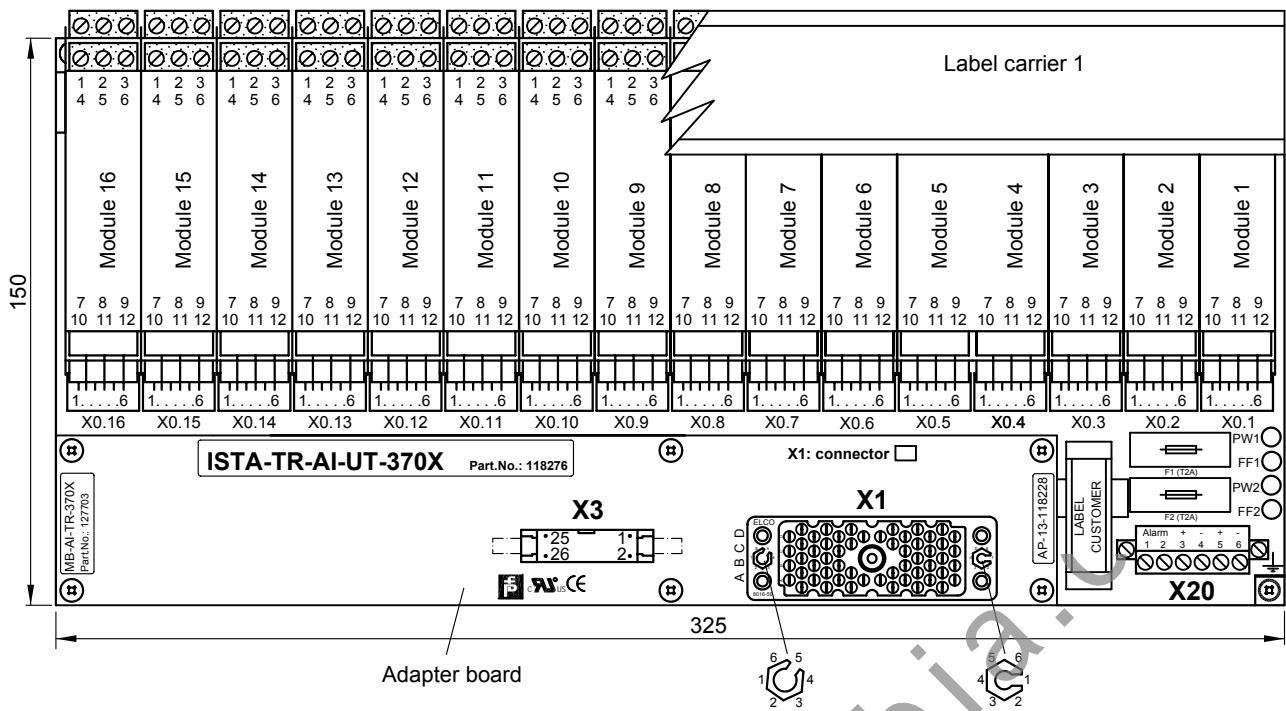

**APPLICATION:**  
**TRICONEX I/O card 3703E**  
 16 points, non commoned, diff., DC coupled

Module 1 ... 16, channels 1 ... 16

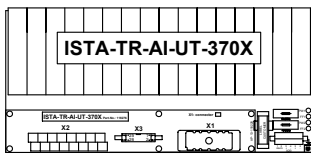

**APPLICATION:**  
**TRICONEX I/O card 3700 / 3700A / 3701 (2 x ISTA-TR-AI-UT-370X-118276)**  
 16 + 16 points, non commoned, diff., DC coupled

Motherboard: connected with connector #B  
 Module 1 ... 16, channels 1 ... 16

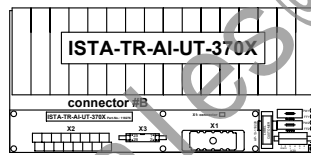

Motherboard: connected with connector #A  
 Module 1 ... 16, channels 1 ... 16

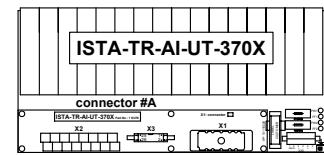

Name	Note
X1	56 pin female system connector ELCO (small key: 1, large key: 5)
X3	26 pin HART connector
X0.1 .... 16	6 pin male terminals for cable tree FSY....
X20.3 .... 6	Power supply screw terminals
X20.1, X20.2	Alarm screw terminal
F1, F2	Fuse
PW1, PW2, FF1, FF2	LEDs for power and power failure

**Ordering information: ISTA-TR-AI-UT-370X-118276**

Basic components:	Description
<b>16 pieces:</b> KFD2-UT-Ex1 *) (AI)	KF-Module type (function)
<b>1 piece:</b> MB-AI-TR-370X-127703	Motherboard without modules
<b>composed by:</b>	
1 piece: MB-16U5L-103681	Motherboard without modules, adapter board, FSY cable tree and Label carrier
1 piece: AP-13-118228	Adapter board
1 piece: KFD0-LC1-16M-99144	Label carrier 1
16 pieces: FSY-L450-98833	Cable tree connection KF-Module-Motherboard

\*) No HART communication

**Note:**  
 For application with module type KFD2-STC4-EX1 see part nr. 118275 and 118261 drawing nr. 36-7463

22.03.02	KT	vB	Sb/vB	
Date	S TZ	Off. in ch.	contr. techn.	contr. Norm
Dept.: PA-VP	Nr. <b>36-7175e</b>			
Up date: 17.06.08	vB	Replaces: 116534/ 36-7416	Sheet 1	
MB-16U5L	Scale: 1 : 2, 1 : 8	of 3		



**PEPPERL+FUCHS**  
 Mannheim-Schönau

Motherboard unit  
 Analog Input - HART  
 16 channels  
**ISTA-TR-AI-UT-370X**

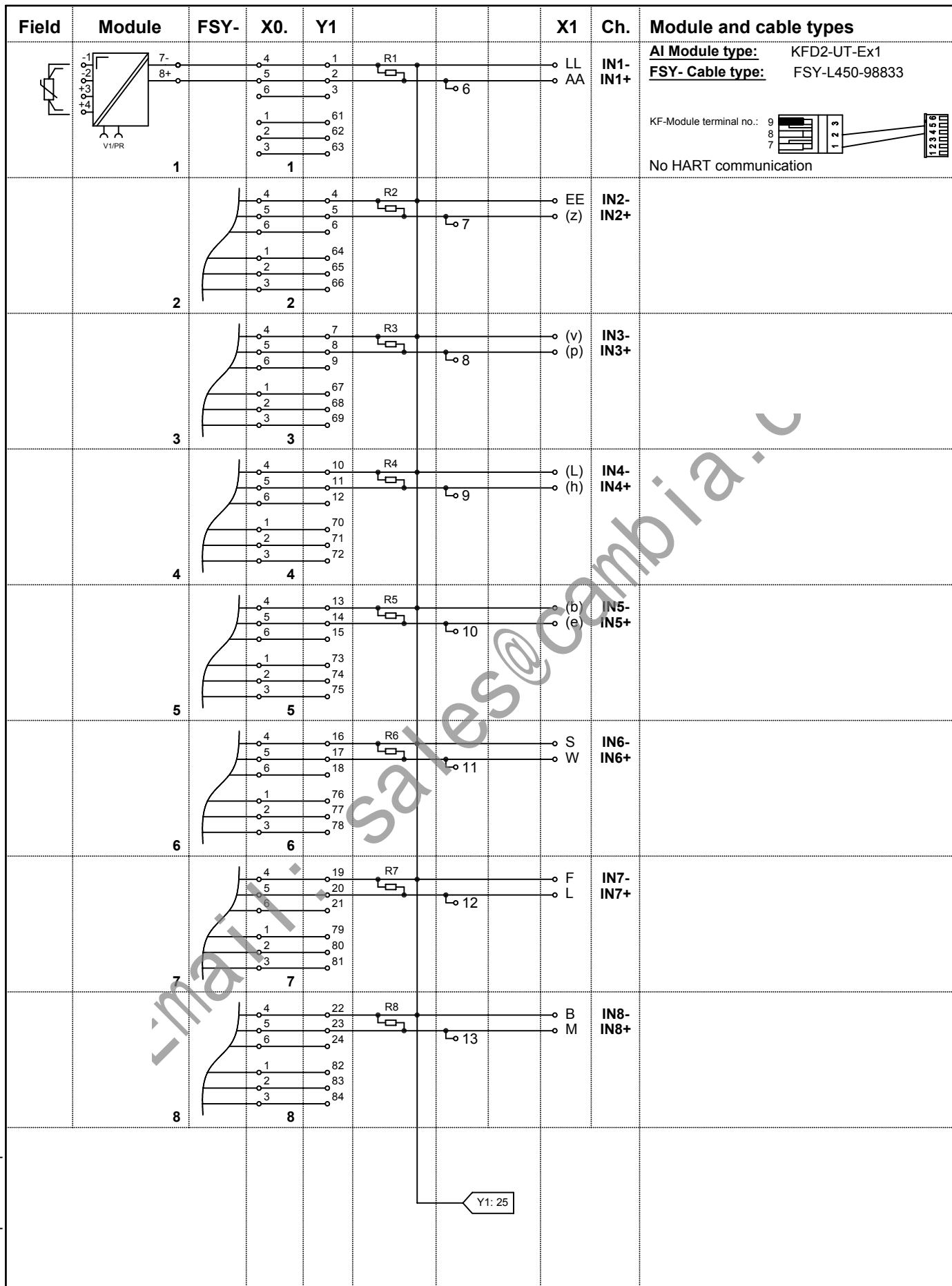

mailto:sales@cambia.it

	<b>PEPPERL+FUCHS</b> Mannheim-Schönau	Motherboard unit Analog Input - HART 16 channels <b>ISTA-TR-AI-UT-370X</b>	22.03.02		KT	vB	Sb/vB		
			Date	S	TZ	Off. in ch.	contr. techn.	contr. Norm	
			Dept.: PA-VP				<b>Nr. 36-7175e</b>		
			Up date: 17.06.08				Replaces: xxxx / 36-xxxx	Sheet 2	
		MB-16U5L			Scale:	- : -	of 3		

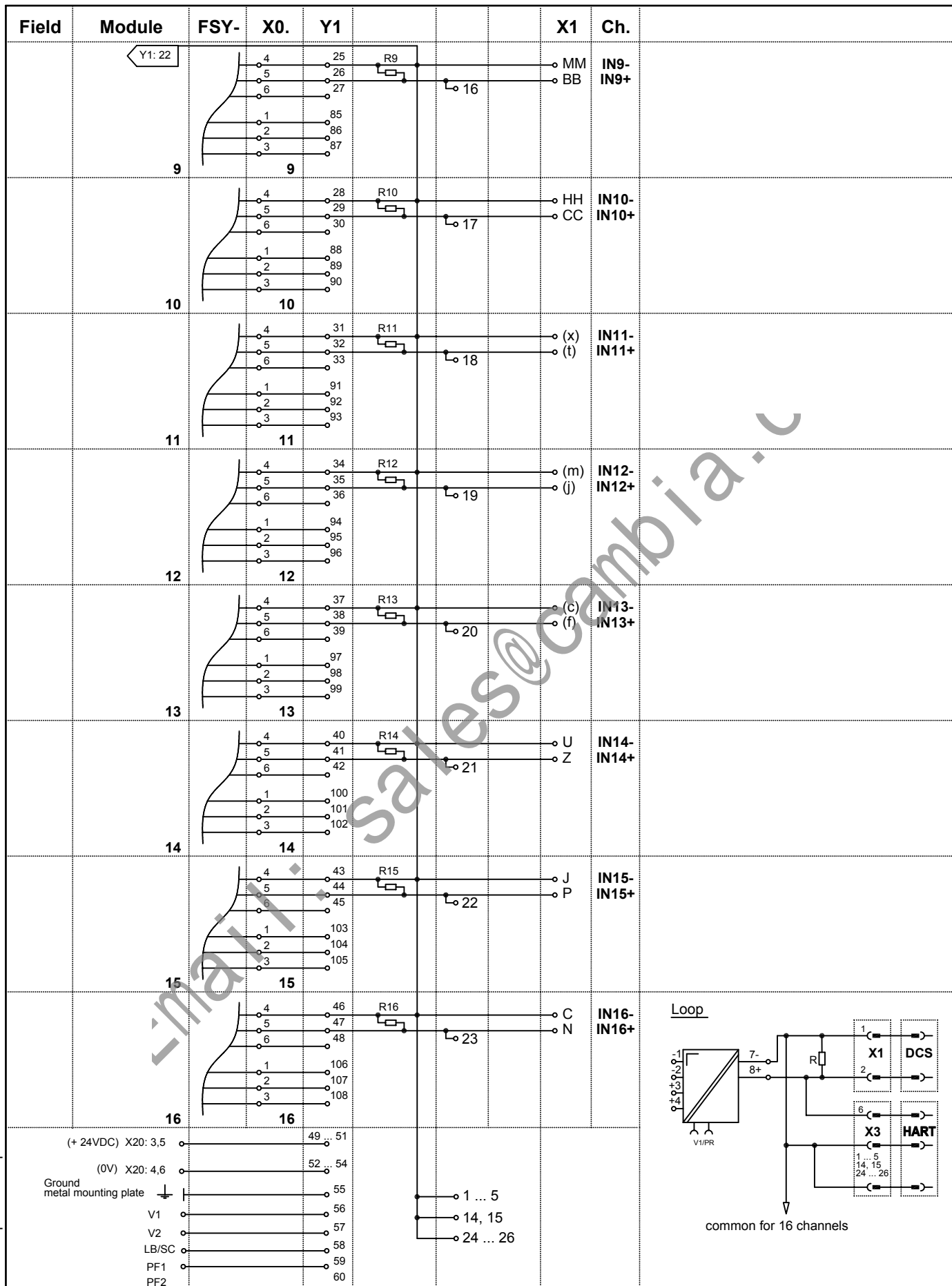

R= 250 ohm resistors 0.01%

Note: Letters in brackets are small letters

23.03.02		KT	vB	Sb/vB	
Date	S	TZ	Off. in ch.	contr. techn.	contr. Norm
Dept.: PA-VP	Nr. <b>36-7175e</b>				
Up date: 17.06.08	Replaces: xxxxx / 36-xxxx		Sheet 3		
MB-16U5L	Scale: - - -		of 3		

**PEPPERL+FUCHS**  
Mannheim-Schönau

Motherboard unit  
Analog Input - HART  
16 channels  
**ISTA-TR-AI-UT-370X**

## 8. 37000 / 3700A / 3701 / 3721 Application

(16 + 16 channels AI)

	Page
<b>Simplified schematic 3700 / 3700A / 3701 / 3721 .....</b>	<b>8- 1</b>
<b>2 x Motherboard ISTA-TR-AI-STC-370X-118275 .....</b>	<b>8- 3</b>
<b>Part No.:</b>	118275
<b>Function:</b>	Analog Input + HART
<b>Channels:</b>	16
<b>System cable:</b>	(ELCO connector)
<b>KF- Module:</b>	KFD2-STC4-Ex1 (single channel)
<b>Simplified schematic:</b>	drawing no. 36-9289
<b>Wiring Diagram:</b>	drawing no. 36-7463
<b>2 x Motherboard ISTA-TR-AI-UT-370X-118276 .....</b>	<b>8- 6</b>
<b>Part No.:</b>	118276
<b>Function:</b>	Analog Input + HART
<b>Channels:</b>	16
<b>System cable:</b>	(ELCO connector)
<b>KF- Module:</b>	KFD2-UT-Ex1 (single channel)
<b>Simplified schematic:</b>	drawing no. 36-9289
<b>Wiring Diagram:</b>	drawing no. 36-7175

**3700 / 3700A / 3701 ANALOG INPUT MODULE**

**Simplified schematic of a typical analog input module  
(1 of 32 points shown)**

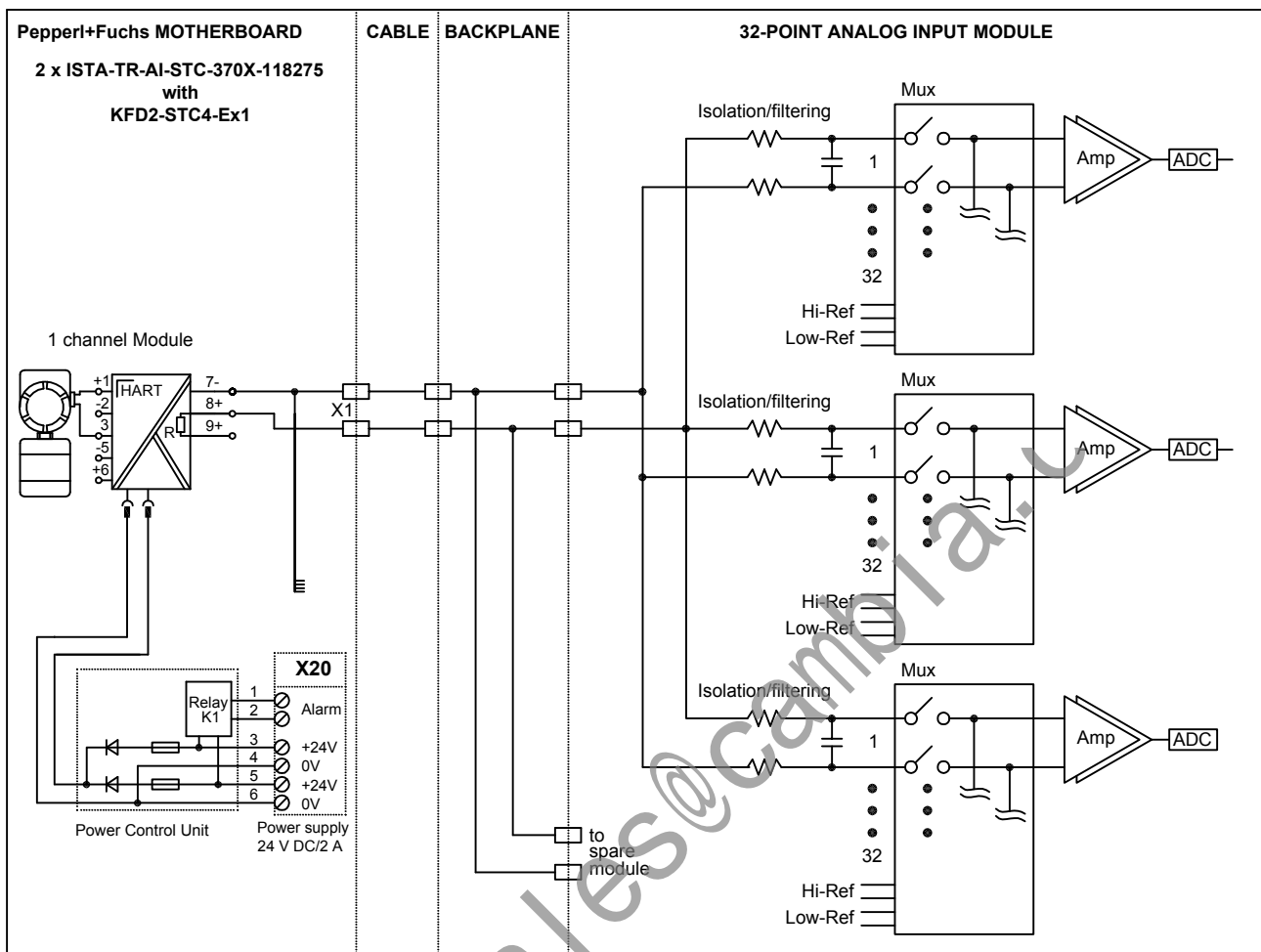

**Pin assignment of connector #A (56 pin ELCO female)**

Pin	AA	KK	LL	z	DD	EE	p	u	v	h	k	l	e	a
Signal	IN1+	*	IN1-	IN2+	*	IN2-	IN3+	*	IN3-	IN4+	*	IN4-	IN5+	*
Pin	b	W	R	S	L	E	F	M	A	B	BB	NN	MM	CC
Signal	IN5-	IN6+	*	IN6-	IN7+		IN7-	IN8+		IN8-	IN9+		IN9-	IN10+
Pin	JJ	HH	t	y	x	j	n	m	f	d	c	Z	V	U
Signal		IN10-	IN11+		IN11-	IN12+		IN12-	IN13+		IN13-	IN14+		IN14-
Pin	P	K	J	N	D	C	T	H	w	FF	r	s	X	Y
Signal	IN15+		IN15-	IN16+		IN16-	CGND	CGND	CGND	CGND	**	**	**	**

**Pin assignment of connector #B (56 pin ELCO female)**

Pin	AA	KK	LL	z	DD	EE	p	u	v	h	k	l	e	a
Signal	IN17+		IN17-	IN18+		IN18-	IN19+		IN19-	IN20+		IN20-	IN21+	
Pin	b	W	R	S	L	E	F	M	A	B	BB	NN	MM	CC
Signal	IN21-	IN22+		IN22-	IN23+		IN23-	IN24+		IN24-	IN25+		IN25-	IN26+
Pin	JJ	HH	t	y	x	j	n	m	f	d	c	Z	V	U
Signal		IN26-	IN27+		IN27-	IN28+		IN28-	IN29+		IN29-	IN30+		IN30-
Pin	P	K	J	N	D	C	T	H	w	FF	r	s	X	Y
Signal	IN31+		IN31-	IN32+		IN32-	CGND	CGND	CGND	CGND	**	**	**	**

\* Reserved for internal use. Do not connect for any purpose.  
 \*\* not used  
 CGND is the chassis ground

02.03.99	AJ	AJ	--	
Date	S	TZ	Off. in ch.	contr. techn.
			contr.	Norm
Dept.: PA-VP	<b>Nr. 36-9289</b>			
Up date: 12.05.03	B: Sb/KT	Replaces: XXXXX / 36-XXXX		Sheet 1
		Scale:	- : -	of 2



**D-TR-3700 / 3700A / 3701**

copyright according to DIN34  
 unauthorized distribution and reproduction prohibited



**3700 / 3700A / 3701 ANALOG INPUT MODULE**

**Simplified schematic of a typical analog input module  
(1 of 32 points shown)**

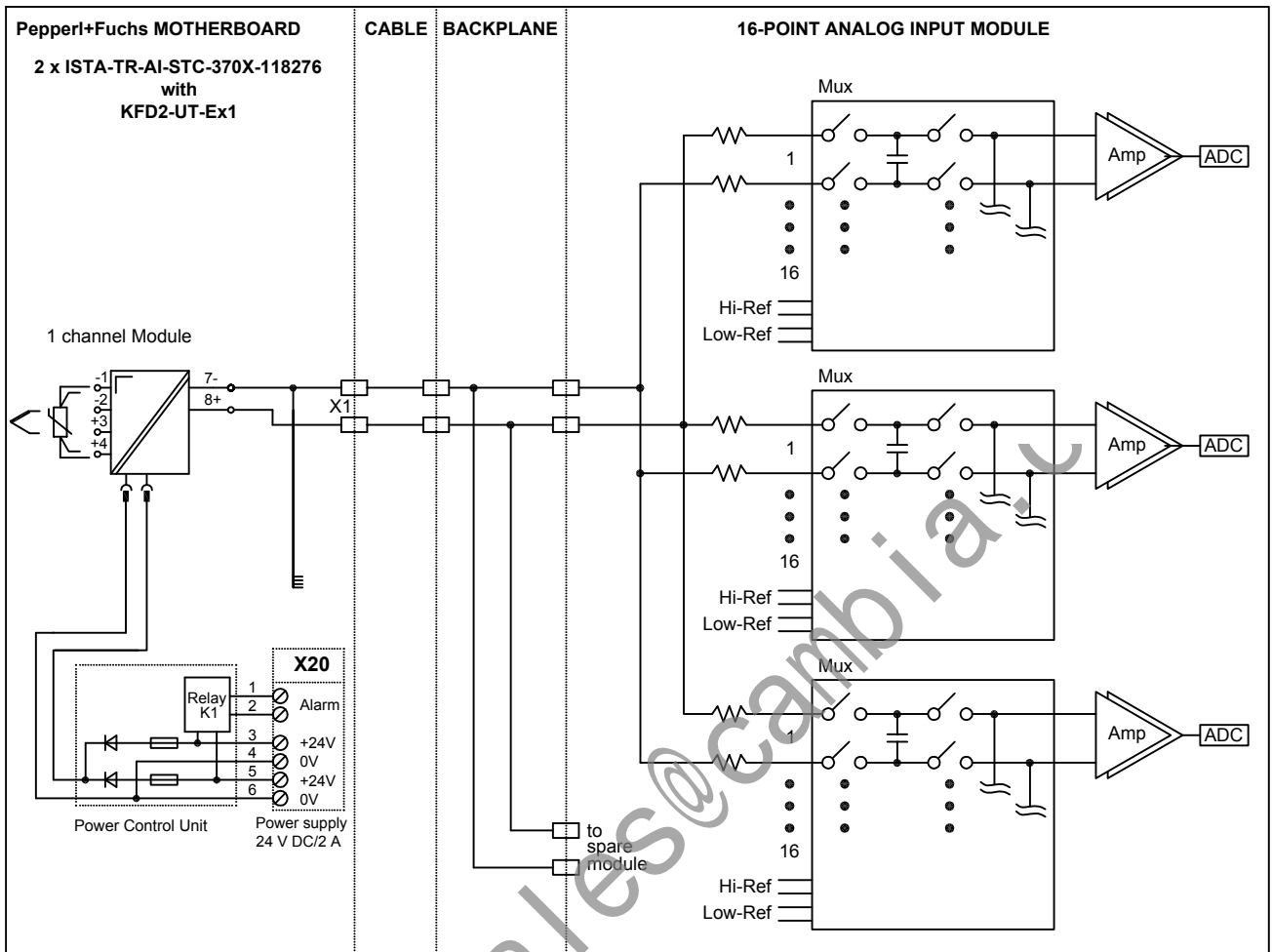

**Pin assignment of connector #A (56 pin ELCO female)**

Pin	AA	KK	LL	z	DD	EE	p	u	v	h	k	l	e	a
Signal	IN1+	*	IN1-	IN2+	*	IN2-	IN3+	*	IN3-	IN4+	*	IN4-	IN5+	*
Pin	b	W	R	S	L	E	F	M	A	B	BB	NN	MM	CC
Signal	IN5-	IN6+	*	IN6-	IN7+		IN7-	IN8+		IN8-	IN9+		IN9-	IN10+
Pin	JJ	HH	t	y	x	j	n	m	f	d	c	Z	V	U
Signal		IN10-	IN11+		IN11-	IN12+		IN12-	IN13+		IN13-	IN14+		IN14-
Pin	P	K	J	N	D	C	T	H	w	FF	r	s	X	Y
Signal	IN15+		IN15-	IN16+		IN16-	CGND	CGND	CGND	CGND	**	**	**	**

**Pin assignment of connector #B (56 pin ELCO female)**

Pin	AA	KK	LL	z	DD	EE	p	u	v	h	k	l	e	a
Signal	IN17+		IN17-	IN18+		IN18-	IN19+		IN19-	IN20+		IN20-	IN21+	
Pin	b	W	R	S	L	E	F	M	A	B	BB	NN	MM	CC
Signal	IN21-	IN22+		IN22-	IN23+		IN23-	IN24+		IN24-	IN25+		IN25-	IN26+
Pin	JJ	HH	t	y	x	j	n	m	f	d	c	Z	V	U
Signal		IN26-	IN27+		IN27-	IN28+		IN28-	IN29+		IN29-	IN30+		IN30-
Pin	P	K	J	N	D	C	T	H	w	FF	r	s	X	Y
Signal	IN31+		IN31-	IN32+		IN32-	CGND	CGND	CGND	CGND	**	**	**	**

\* Reserved for internal use. Do not connect for any purpose.  
\*\* not used  
CGND is the chassis ground

12.05.03	KT	Sb	Sb	
Date	S	TZ	Off. in ch.	contr. techn.
			contr. Norm	



**3700 / 3700A / 3701**

Dept.: PA-VP	<b>Nr. 36-9289</b>
vB/Bro	Replaces: XXXXX / 36-XXXX
Up date: 23.03.04	Sheet 2
Scale: - : -	of 2

copyright according to DIN34  
unauthorized distribution and reproduction prohibited

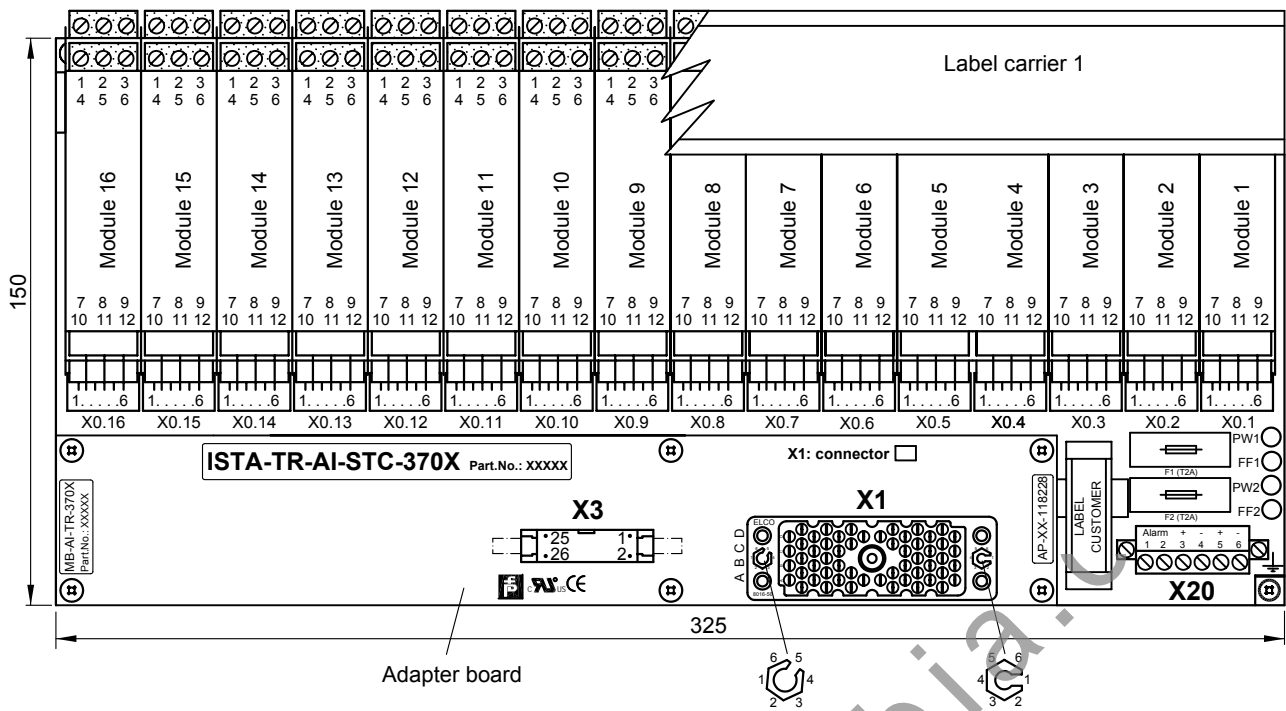

**APPLICATION:**  
**TRICONEX I/O card 3703E**  
 16 points, non commoned, diff., DC coupled

Module 1 ... 16, channels 1 ... 16

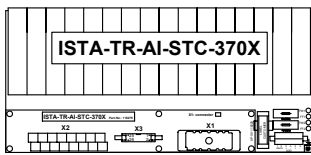

**APPLICATION:**  
**TRICONEX I/O card 3700 / 3700A / 3701 (2 x ISTA-TR-AI-STC-370X-XXXXX)**  
 16 + 16 points, non commoned, diff., DC coupled

Motherboard: connected with connector #B  
 Module 1 ... 16, channels 1 ... 16

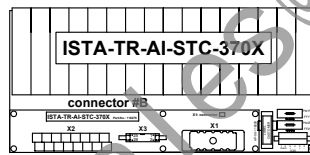

Motherboard: connected with connector #A  
 Module 1 ... 16, channels 1 ... 16

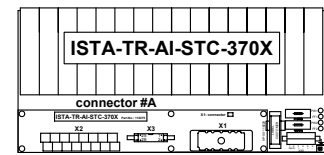

Name	Note
X1	56 pin female system connector ELCO (small key: 1, large key: 5)
X3	26 pin HART connector male
X0.1 ... 16	6 pin male terminals for cable tree FSY....
X20.3 ... 6	Power supply screw terminals
X20.1, X20.2	Alarm screw terminal
F1, F2	Fuse
PW1, PW2, FF1, FF2	LEDs for power and power failure

Ordering information:	ISTA-TR-AI-STC-370X-118275	ISTA-TR-AI-STC-370X-190081	Description
<b>Basic components:</b>			
<b>16 pieces:</b>	<b>KFD2-STC4-Ex1 (AI)</b>	<b>KFD2-STC4-1 (AI)</b>	KF-Module type (function)
<b>1 piece:</b>	<b>MB-AI-TR-370X-118261</b>	<b>MB-AI-TR-370X-190082</b>	Motherboard without modules
<b>composed by:</b>			
1 piece:	MB-16U5L-103681	MB-16U5L-103681	Basis Motherboard (*)
1 piece:	AP-11-118228	AP-12-118228	Adapter board
1 piece:	KFD0-LC1-16M-99144	KFD0-LC1-16M-99144	Label carrier 1
16 pieces:	FSY-L450-98833	FSY-L450-98833	FSY-Cable tree

(\*) Basis Motherboard without modules, adapter board and FSY cable tree (connection between Motherboard and Modules)

**Note:**  
 For application with module type KFD2-UT-EX1 see part nr. 118276 and 127703 drawing nr. 36-7175

21.03.02		KT	vB	Sb/vB	
Date	S	TZ	Off. in ch.	contr. techn.	contr. Norm
Dept.: PA-VP			<b>Nr. 36-7463i</b>		
Up date: 12.06.08	vB	Replaces: 127672-127676 (36-7560)		Sheet	1
MB-16U5L	Scale: 1 : 2, 1 : 8			of	3



Field	Module	FSY-	X0.	Y1		X1	Ch.
	9		9	25 26 27 85 86 87	R9	MM BB 16	IN9- IN9+
	10		10	28 29 30 88 89 90	R10	HH CC 17	IN10- IN10+
	11		11	31 32 33 91 92 93	R11	(x) (t) 18	IN11- IN11+
	12		12	34 35 36 94 95 96	R12	(m) (j) 19	IN12- IN12+
	13		13	37 38 39 97 98 99	R13	(c) (f) 20	IN13- IN13+
	14		14	40 41 42 100 101 102	R14	U Z 21	IN14- IN14+
	15		15	43 44 45 103 104 105	R15	J P 22	IN15- IN15+
	16		16	46 47 48 106 107 108	R16	C N 23	IN16- IN16+
				49 ... 51 52 ... 54 55 56 57 58 59 60		1 ... 5 14, 15 24 ... 26	
				(+ 24VDC) X20: 3,5 (0V) X20: 4,6 Ground metal mounting plate V1 V2 LB/SC PF1 PF2			

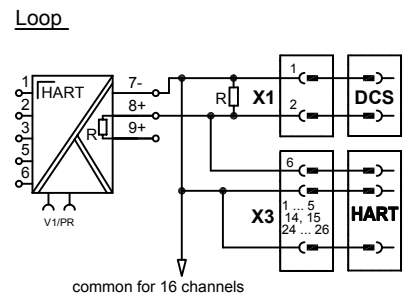

R= 250 ohm resistors 0.01%  
 Note: Letters in brackets are small letters

22.03.02		KT	vB	Sb/vB	
Date	S	TZ	Off. in ch.	contr. techn.	contr. Norm
Dept.: PA-VP	Nr. 36-7463i				
Up date: 12.06.08	Replaces: 127672-127676 (36-7560)		Sheet 3		
MB-16U5L	Scale: - - -		of 3		

**PEPPERL+FUCHS**  
 Mannheim-Schönau

Motherboard unit  
 Analog Input - HART  
 16 channels  
**ISTA-TR-AI-STC-370X**

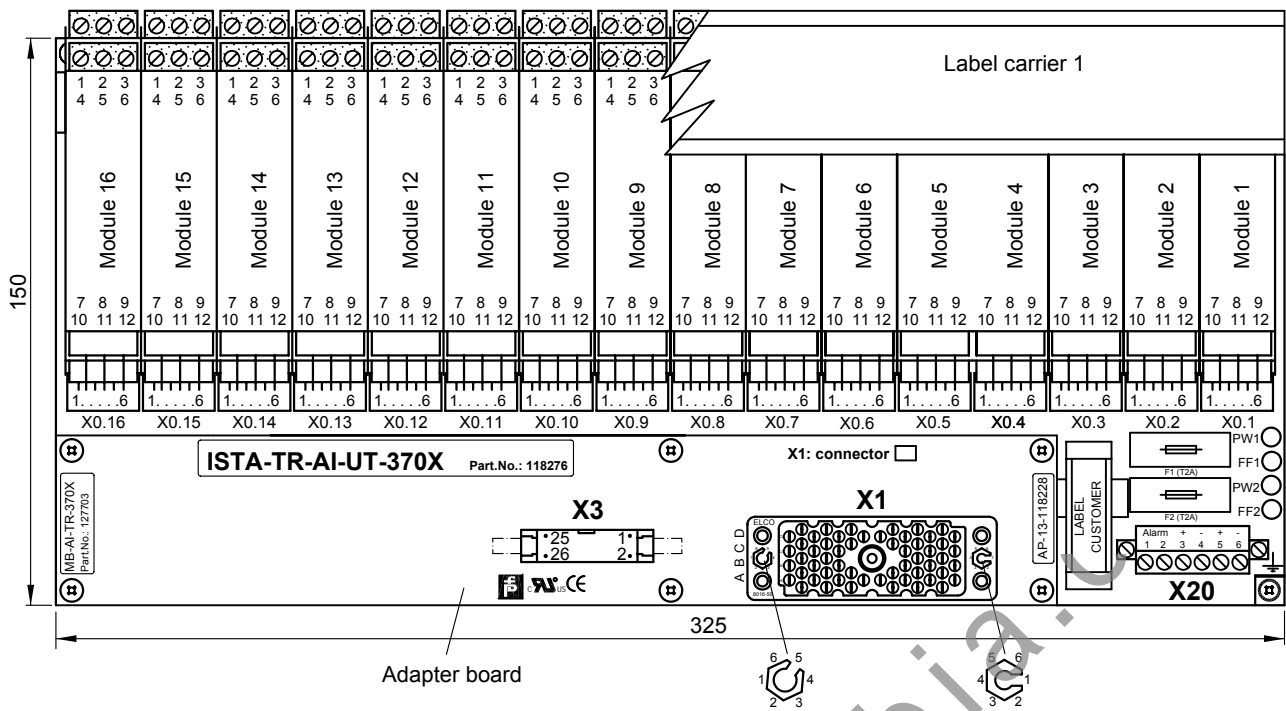

**APPLICATION:**

**TRICONEX I/O card 3703E**

16 points, non commoned, diff., DC coupled

Module 1 ... 16, channels 1 ... 16

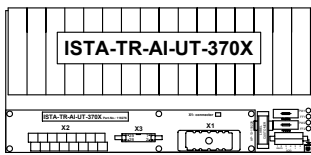

**APPLICATION:**

**TRICONEX I/O card 3700 / 3700A / 3701 (2 x ISTA-TR-AI-UT-370X-118276)**

16 + 16 points, non commoned, diff., DC coupled

Motherboard: connected with connector #B  
Module 1 ... 16, channels 1 ... 16

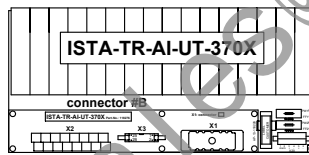

Motherboard: connected with connector #A  
Module 1 ... 16, channels 1 ... 16

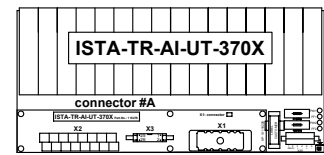

Name	Note
X1	56 pin female system connector ELCO (small key: 1, large key: 5)
X3	26 pin HART connector
X0.1 .... 16	6 pin male terminals for cable tree FSY....
X20.3 .... 6	Power supply screw terminals
X20.1, X20.2	Alarm screw terminal
F1, F2	Fuse
PW1, PW2, FF1, FF2	LEDs for power and power failure

**Ordering information: ISTA-TR-AI-UT-370X-118276**

Basic components:	Description
<b>16 pieces:</b> KFD2-UT-Ex1 *) (AI)	KF-Module type (function)
<b>1 piece:</b> MB-AI-TR-370X-127703	Motherboard without modules
<b>composed by:</b>	
1 piece: MB-16U5L-103681	Motherboard without modules, adapter board, FSY cable tree and Label carrier
1 piece: AP-13-118228	Adapter board
1 piece: KFD0-LC1-16M-99144	Label carrier 1
16 pieces: FSY-L450-98833	Cable tree connection KF-Module-Motherboard

\*) No HART communication

**Note:**

For application with module type KFD2-STC4-EX1 see part nr. 118275 and 118261 drawing nr. 36-7463

22.03.02	KT	vB	Sb/vB	
Date	S TZ	Off. in ch.	contr. techn.	contr. Norm
Dept.: PA-VP	Nr. <b>36-7175e</b>			
Up date: 17.06.08	vB	Replaces: 116534/ 36-7416	Sheet 1	
MB-16U5L	Scale: 1 : 2, 1 : 8	of 3		



**PEPPERL+FUCHS**  
Mannheim-Schönau

Motherboard unit  
Analog Input - HART  
16 channels  
**ISTA-TR-AI-UT-370X**

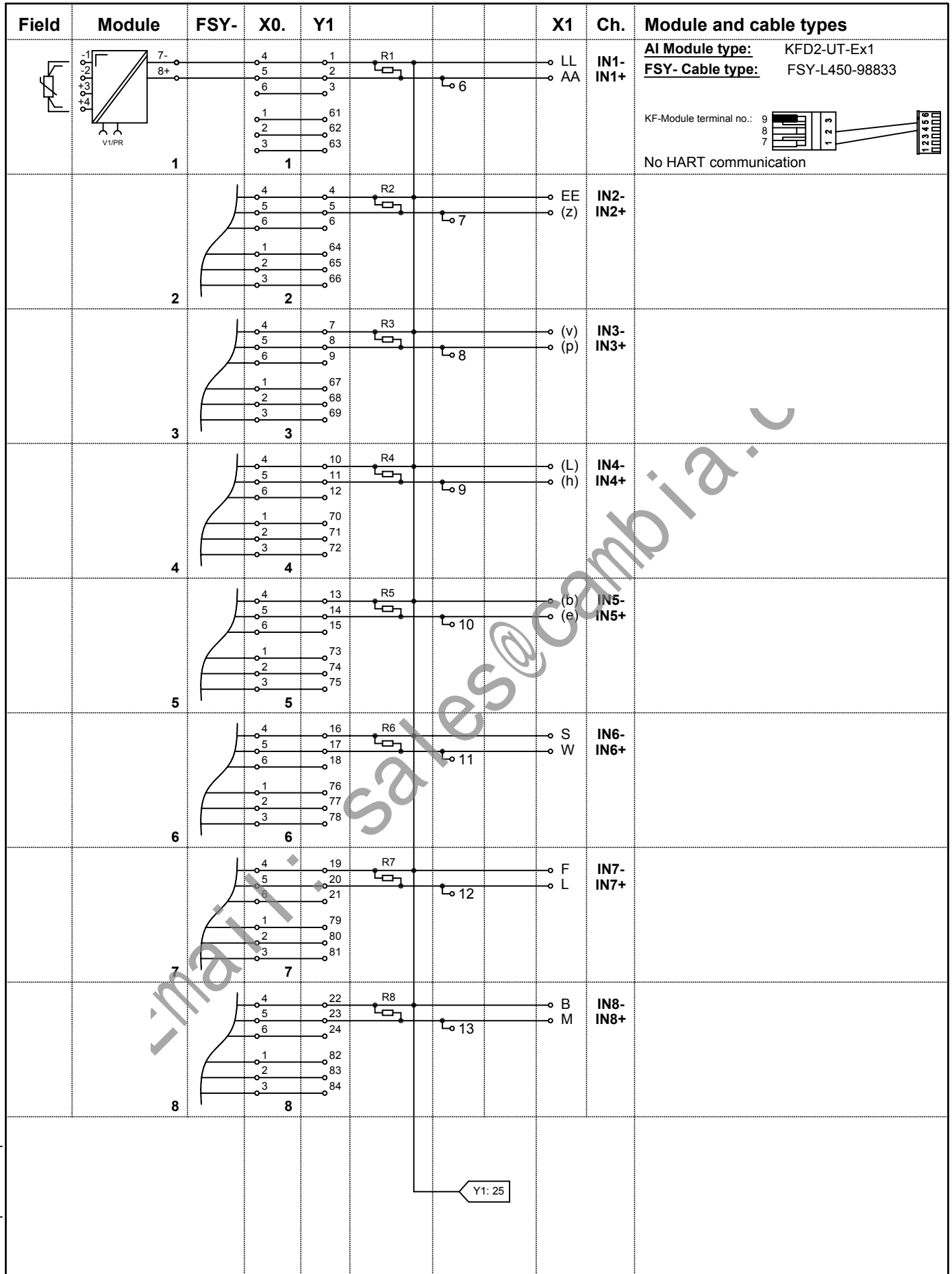

	Motherboard unit Analog Input - HART 16 channels <b>ISTA-TR-AI-UT-370X</b>		22.03.02	KT	vB	Sb/vB	
	Date	S TZ	Off. in ch.	contr. techn.	contr. Norm		
	Dept.: PA-VP	Nr. <b>36-7175e</b>		Replaces:		Sheet 2	
	Up date: 17.06.08	xxxx / 36-xxxx		Scale:	- -	of 3	

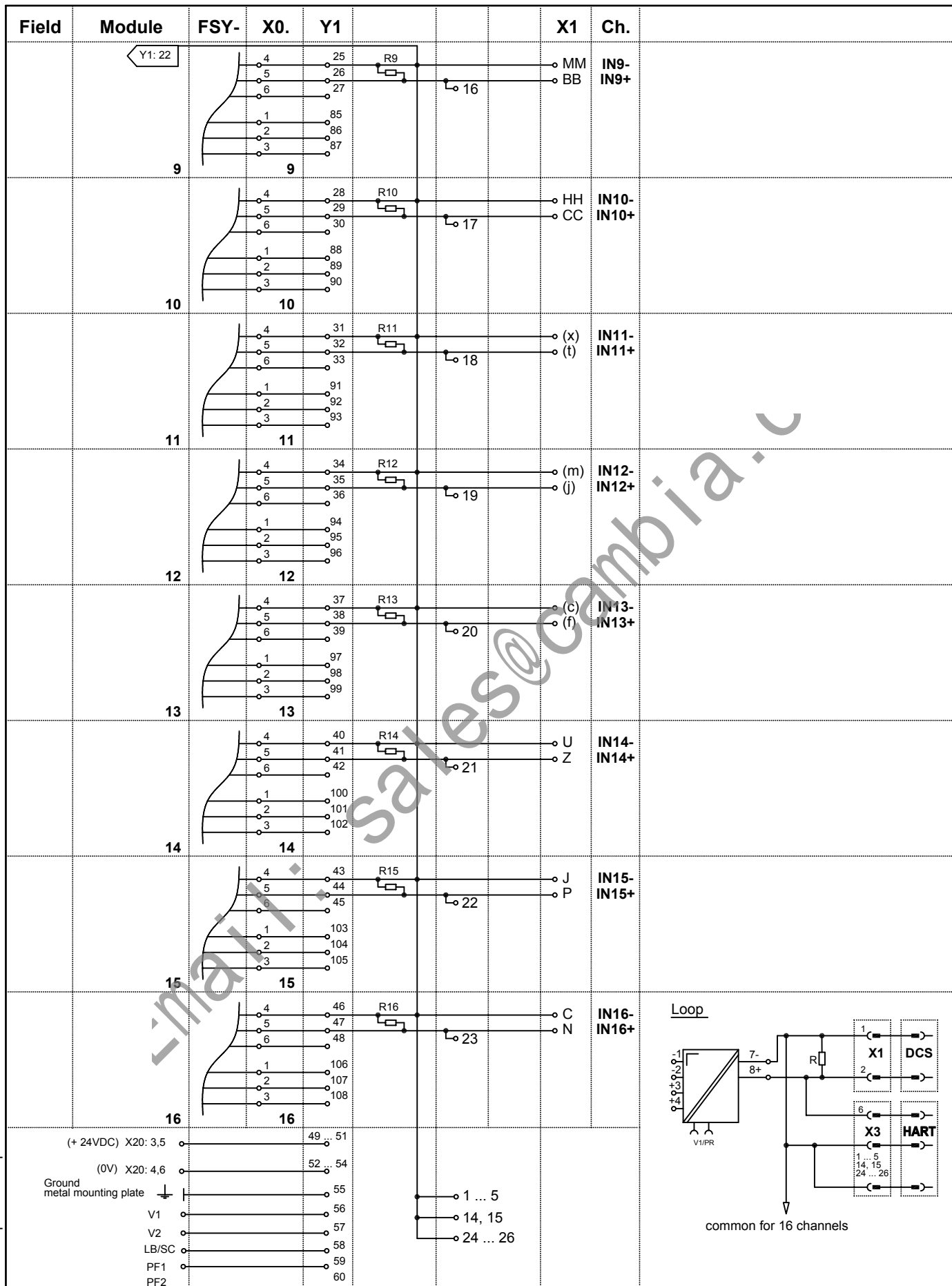

R= 250 ohm resistors 0.01%

Note: Letters in brackets are small letters

23.03.02		KT	vB	Sb/vB	
Date	S	TZ	Off. in ch.	contr. techn.	contr. Norm
Dept.: PA-VP	Nr. <b>36-7175e</b>				
Up date: 17.06.08	Replaces: xxxxx / 36-xxxx		Sheet 3		
MB-16U5L	Scale: - - -		of 3		

**PF**  
**PEPPERL+FUCHS**  
 Mannheim-Schönau

Motherboard unit  
 Analog Input - HART  
 16 channels  
**ISTA-TR-AI-UT-370X**

## 9. 3704E / 3720 Application

(32 + 32 channels AI)

	Page
<b>Simplified schematic 3704E / 3720 .....</b>	9- 1
<b>2 x Motherboard ISTA-TR-AI-STC-370X-118290 .....</b>	9- 2
<b>Part No.:</b>	118290
<b>Function:</b>	Analog Input + HART
<b>Channels:</b>	32
<b>System cable:</b>	(ELCO connector)
<b>KF- Module:</b>	KFD2-STC4-Ex1 (single channel)
<b>Simplified schematic:</b>	drawing no. 36-9290
<b>Wiring Diagram:</b>	drawing no. 36-7468

email: sales@cambia.it



# 3704E ANALOG INPUT MODULE

## Simplified schematic of a typical 64-point analog input module (1 of 64 points shown)

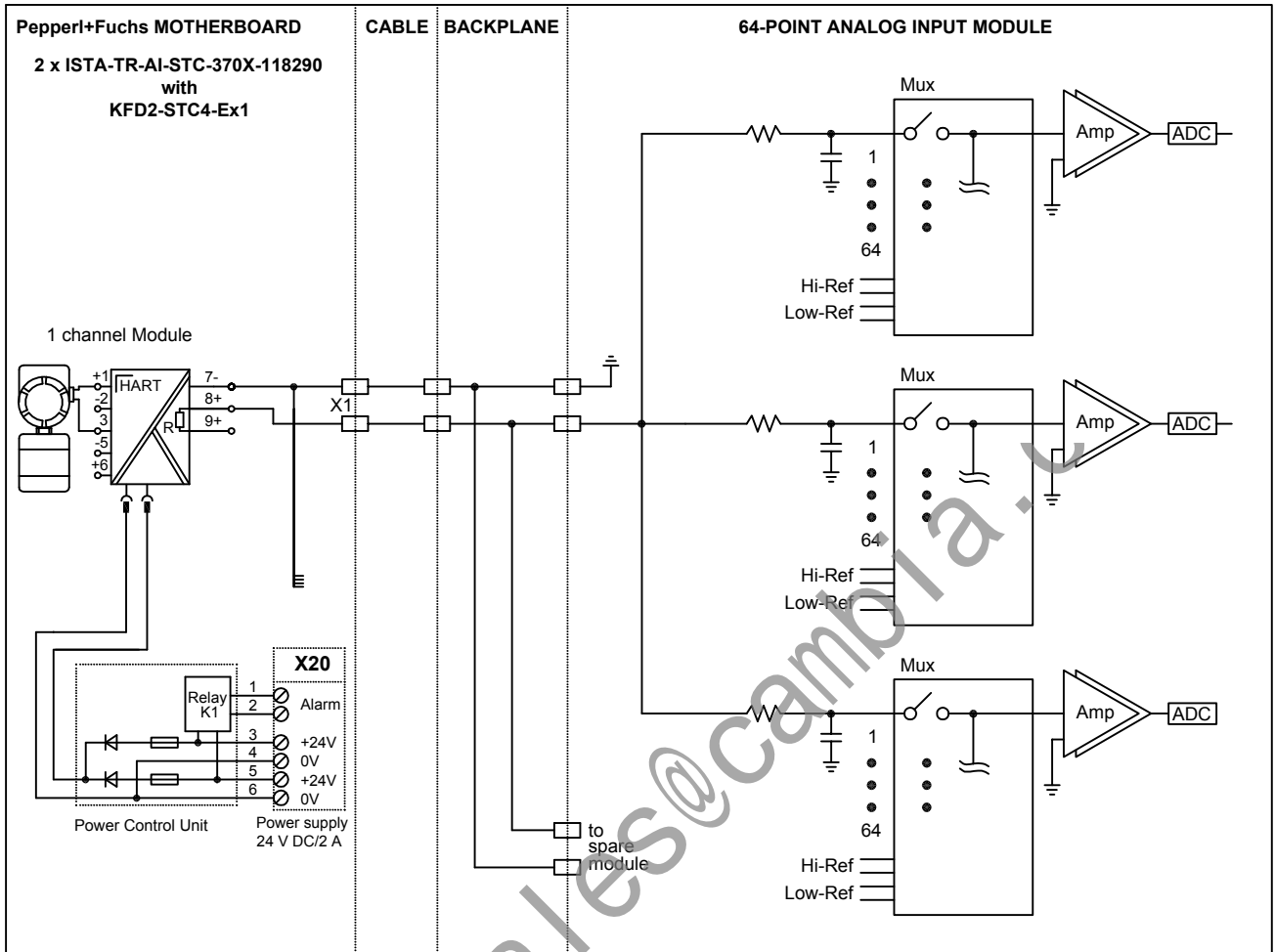

### Pin assignment of connector #A (56 pin ELCO female)

Pin	AA	KK	LL	z	DD	EE	p	u	v	h	k	l	e	a
Signal	IN1	*	IN2	IN3	PWR	IN4	IN5	*	IN6	IN7	PWR	IN8	IN9	*
Pin	b	W	R	S	L	E	F	M	A	B	BB	NN	MM	CC
Signal	IN10	IN11	PWR	IN12	IN13	RTN	IN14	IN15	RTN	IN16	IN17	RTN	IN18	IN19
Pin	JJ	HH	t	y	x	j	n	m	f	d	c	Z	V	U
Signal	RTN	IN20	IN21	RTN	IN22	IN23	RTN	IN24	IN25	RTN	IN26	IN27	RTN	IN28
Pin	P	K	J	N	D	C	T	H	w	FF	r	s	X	Y
Signal	IN29	RTN	IN30	IN31	RTN	IN32	CGND	CGND	CGND	CGND	**	**	**	**

### Pin assignment of connector #B (56 pin ELCO female)

Pin	AA	KK	LL	z	DD	EE	p	u	v	h	k	l	e	a
Signal	IN33	RTN	IN34	IN35	RTN	IN36	IN37	RTN	IN38	IN39	RTN	IN40	IN41	RTN
Pin	b	W	R	S	L	E	F	M	A	B	BB	NN	MM	CC
Signal	IN42	IN43	RTN	IN44	IN45	RTN	IN46	IN47	RTN	IN48	IN49	RTN	IN50	IN51
Pin	JJ	HH	t	y	x	j	n	m	f	d	c	Z	V	U
Signal	RTN	IN52	IN53	RTN	IN54	IN55	RTN	IN56	IN57	RTN	IN58	IN59	RTN	IN60
Pin	P	K	J	N	D	C	T	H	w	FF	r	s	X	Y
Signal	IN61	RTN	IN62	IN63	RTN	IN64	CGND	CGND	CGND	CGND	**	**	**	**

\* Reserved for internal use. Do not connect for any purpose.  
 \*\* not used  
 CGND is the chassis ground

19.08.99		AJ	AJ	--	
Date	S	TZ	Off. in ch.	contr. techn.	contr. Norm



**D-TR-3704E**

Dept.: PA-VP	Nr. <b>36-9290</b>
vB/Bro	Replaces: XXXXX / 36-XXXX
Up date: 23.03.04	Sheet 1
Scale: - : -	of 1

copyright according to DIN34 unauthorized distribution and reproduction prohibited

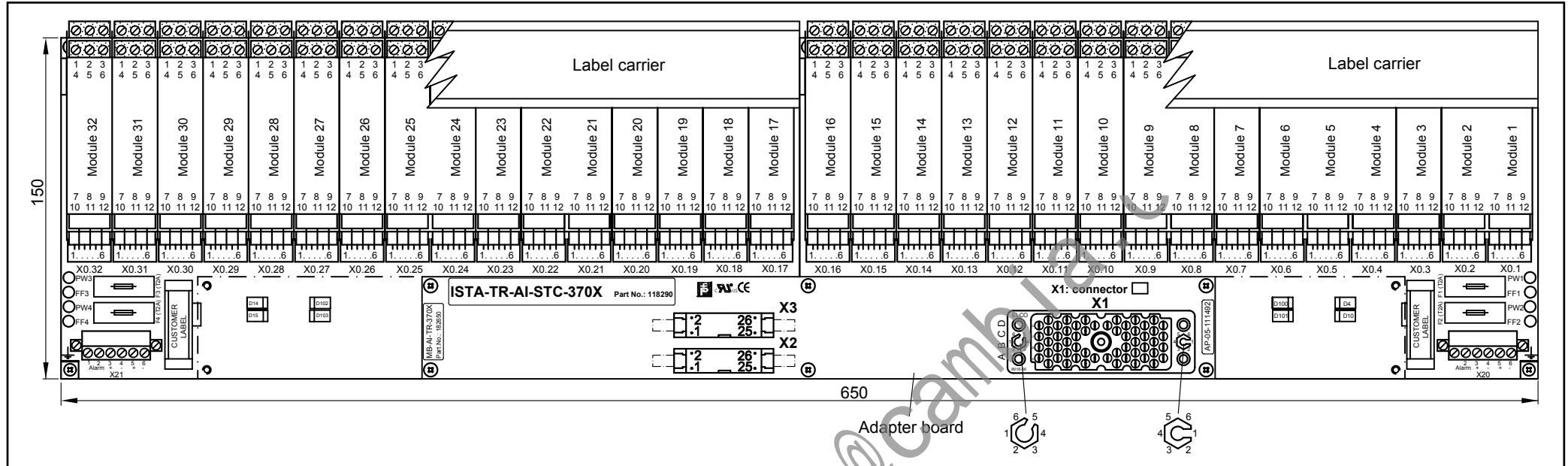

**APPLICATION:**

**TRICONEX I/O card 3704E: will be required 2 x ISTA-TR-AI-STC-370X-118290; 64 points, commoned**

Motherboard 2: connected with connector #B  
 Module 1 ... 32, channels 33 ... 64

Motherboard 1: connected with connector #A  
 Module 1 ... 32, channels 1 ... 32



Both power supplies (X20, X21) have to be connected

Name	Note
X1	56 pin female system connector ELCO (small key: 1, large key: 5)
X2, X3	26 pin male HART connector
X0.1 .. 32	6 pin male terminals for cable tree FSY-....
X20, X21	Screw terminals (Power feed on X20 and X21 must be same)
X20, 1, 2 X21, 1, 2	Alarm screw terminal
F1, F2 F3, F4	Fuse
PW1,2,3,4 FF1,2,3,4	LEDs for power and power failure

Ordering information: ISTA-TR-AI-STC-370X-118290		Description
<b>Basic components:</b>		
<b>32 pieces:</b>	<b>KFD2-STC4-Ex1 (AI)</b>	KF-Module type (function)
<b>1 piece:</b>	<b>MB-AI-TR-370X-182650</b>	Motherboard without modules
<b>composed by:</b>		
1 piece:	MB-32U1-103678	Motherboard without modules, adapter board, FSY cable tree and Label carrier
1 piece:	AP-05-111492	Adapter board
2 pieces:	KFD0-LC1-16M-99144	2 x Label carrier 1
32 pieces:	FSY-L450-98833	Cable tree connection KF-Module-Motherboard



**PEPPERL+FUCHS**  
 Mannheim-Schönau

Motherboard unit  
 Analog Input - HART  
 32 channels  
**ISTA-TR-AI-STC-370X**

11.04.02		KT	vB	Sb/vB	
Date	S	TZ	Off. in ch.	contr. techn.	contr. Norm
Dept.: PA-VP	Up date: 18.06.08		Replaces: vB XXXXX / 36-XXXX		Sheet 1
MB-32U1	Scale: 1:2.5, 1:12.5				of 3

Field	Module	FSY	X0.	Y1	X2	X1	Ch.	Field	Module	FSY	X0.	Y1	X2	X1	Ch.	
	1	1	4	1	R1	6	AA	IN1	9	9	4	25	R9	16	(e)	IN9
	2	2	4	4	R2	7	LL	IN2	10	10	4	28	R10	17	(b)	IN10
	3	3	4	7	R3	8	(z)	IN3	11	11	4	31	R11	18	W	IN11
	4	4	4	10	R4	9	EE	IN4	12	12	4	34	R12	19	S	IN12
	5	5	4	13	R5	10	(p)	IN5	13	13	4	37	R13	20	L	IN13
	6	6	4	16	R6	11	(v)	IN6	14	14	4	40	R14	21	F	IN14
	7	7	4	19	R7	12	(h)	IN7	15	15	4	43	R15	22	M	IN15
	8	8	4	22	R8	13	(L)	IN8	16	16	4	46	R16	23	B	IN16

**Module and cable types**

**AI Module type:**  
KFD2-STC4-Ex1

**FSY - Cable type:**

FSY-L450-98833

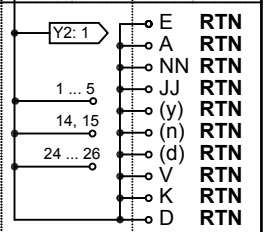
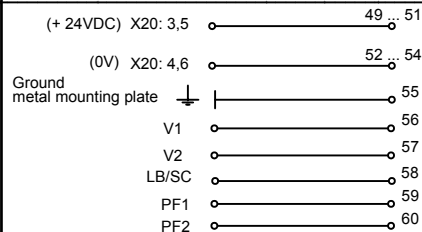

11.04.02	KT	vB	Sb/vB	
Date	S TZ	Off. in ch.	contr. techn.	contr. Norm
Dept.: PA-VP	vB		Nr. <b>36-7468b</b>	
Up date: 18.06.08	Replaces: XXXXX / 36-XXXX		Sheet 2	
MB-32U1	Scale: - : -		of 3	

Motherboard unit  
Analog Input - HART  
32 channels  
**ISTA-TR-AI-STC-370X**

Field	Module	FSY	X0.	Y2	X3	X1	Ch.	Field	Module	FSY	X0.	Y2	X3	X1	Ch.
	17		4 5 6	1 2 3	R17	6	BB IN17		25		4 5 6	25 26 27	R25	16	(f) IN25
	18		4 5 6	4 5 6	R18	7	MM IN18		26		4 5 6	28 29 30	R26	17	(c) IN26
	19		4 5 6	7 8 9	R19	8	CC IN19		27		4 5 6	31 32 33	R27	18	Z IN27
	20		4 5 6	10 11 12	R20	9	HH IN20		28		4 5 6	34 35 36	R28	19	U IN28
	21		4 5 6	13 14 15	R21	10	(t) IN21		29		4 5 6	37 38 39	R29	20	P IN29
	22		4 5 6	16 17 18	R22	11	(x) IN22		30		4 5 6	40 41 42	R30	21	J IN30
	23		4 5 6	19 20 21	R23	12	(j) IN23		31		4 5 6	43 44 45	R31	22	N IN31
	24		4 5 6	22 23 24	R24	13	(m) IN24		32		4 5 6	46 47 48	R32	23	C IN32
<p>Loop P+F              HART              7-              8+              9+              V1, V2              LB/SC              PF1              PF2              X1              X2              X3              DCS              HART              common for 32 channels              DCS common for 32 channels</p>								<p>(+ 24VDC) X21: 3,5 49... 51              (0V) X21: 4,6 52... 54              Ground metal mounting plate              V1              V2              LB/SC              PF1              PF2</p> <p>DD              (k) PWR,              R RTN</p> <p>1...5              14, 15              24...26</p>							

R = resistor 250 Ohm 0,01%  
 Note: Letters in brackets are small letters

11.04.02		KT	vB	Sb/vB	
Date	S	TZ	Off. in ch.	contr. techn.	contr. Norm
Dept.: PA-VP	vB		Nr. <b>36-7468b</b>		
Up date: 18.06.08	Replaces: XXXXX / 36-XXXX		Sheet 3		
MB-32U1	Scale: - : -		of 3		

**PEPPERL+FUCHS**  
 Mannheim-Schönau

Motherboard unit  
 Analog Input - HART  
 32 channels  
**ISTA-TR-AI-STC-370X**

## 10. 3805E Application

(8 channels AO)

	Page
<b>Simplified schematic 3805E</b> .....	10- 1
<b>Motherboard ISTA-TR-AO-SCD-380X-118277</b> .....	10- 2
<b>Part No.:</b>	118277
<b>Function:</b>	Analog Output + HART
<b>Channels:</b>	8
<b>System cable:</b>	(ELCO connector)
<b>KF- Module:</b>	KFD2-SCD-Ex1.LK (single channel)
<b>Simplified schematic:</b>	drawing no. 36-9291
<b>Wiring Diagram:</b>	drawing no. 36-7464

email: sales@cambia.it

# 3805E ANALOG OUTPUT MODULE

Simplified schematic of a typical 8-point commoned-return analog output module  
(1 of 8 points shown)

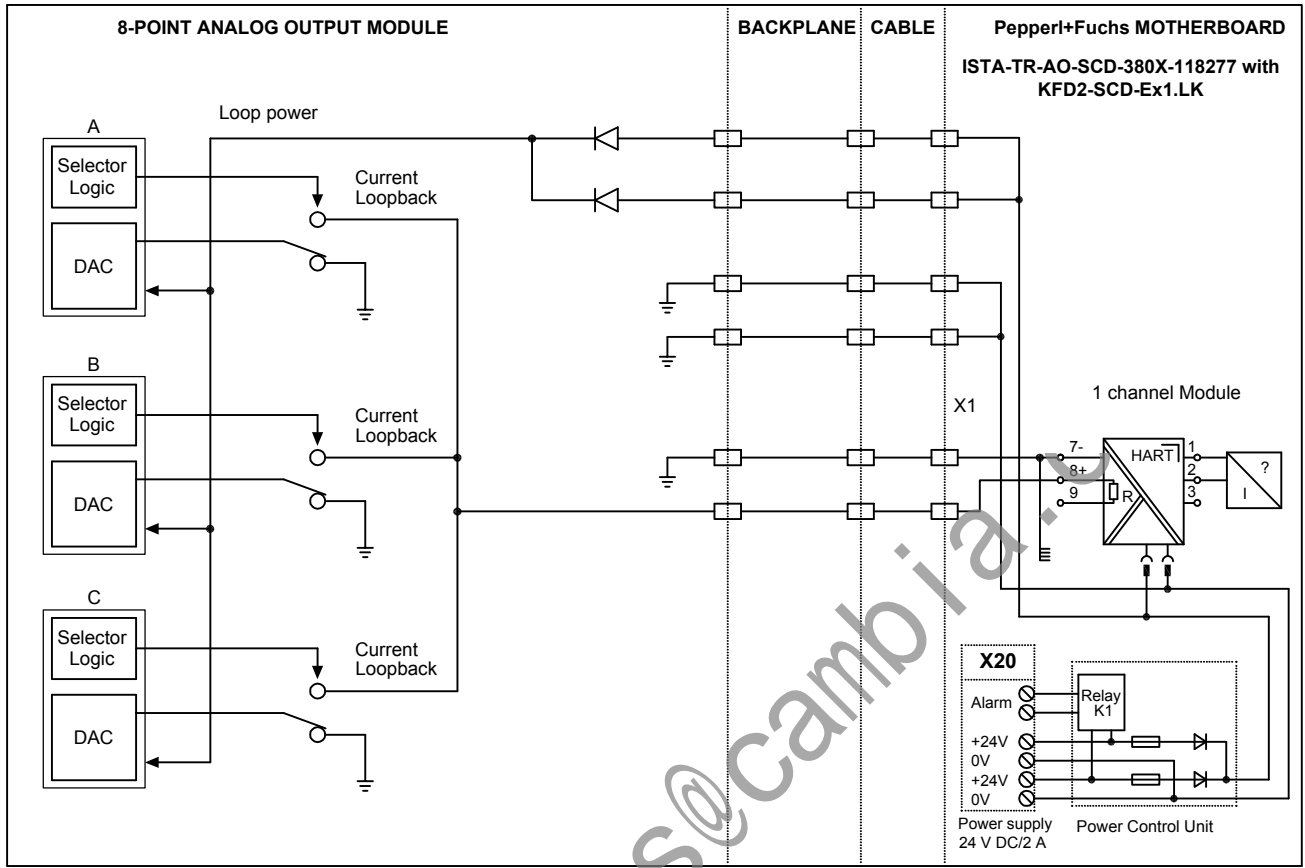

## Pin assignment of connector #A (56 pin ELCO female)

Pin	AA	KK	LL	z	DD	EE	p	u	v	h	k	l	e	a
Signal	OUT1		RTN1	OUT2		RTN2	OUT3		RTN3	OUT4		RTN4	OUT5	
Pin	b	W	R	S	L	E	F	M	A	B	BB	NN	MM	CC
Signal	RTN5	OUT6		RTN6	OUT7		RTN7	OUT8		RTN8				
Pin	JJ	HH	t	y	x	j	n	m	f	d	c	Z	V	U
Signal			PWRA		RTN	PWRB		RTN						
Pin	P	K	J	N	D	C	T	H	w	FF	r	s	X	Y
Signal							CGND	CGND	CGND	CGND	**	**	**	**

\*\* not used

CGND is the chassis ground

02.03.99	AJ	AJ	--	
Date	S	TZ	Off. in ch.	contr. techn.
Dept.: PA-VP	Nr. <b>36-9291</b>			
Up date: 23.03.04	Replaces: XXXXX / 36-XXXX		Sheet 1	
Scale: - : -			of 1	



PEPPERL+FUCHS  
Mannheim-Schönau

D-TR-3805E

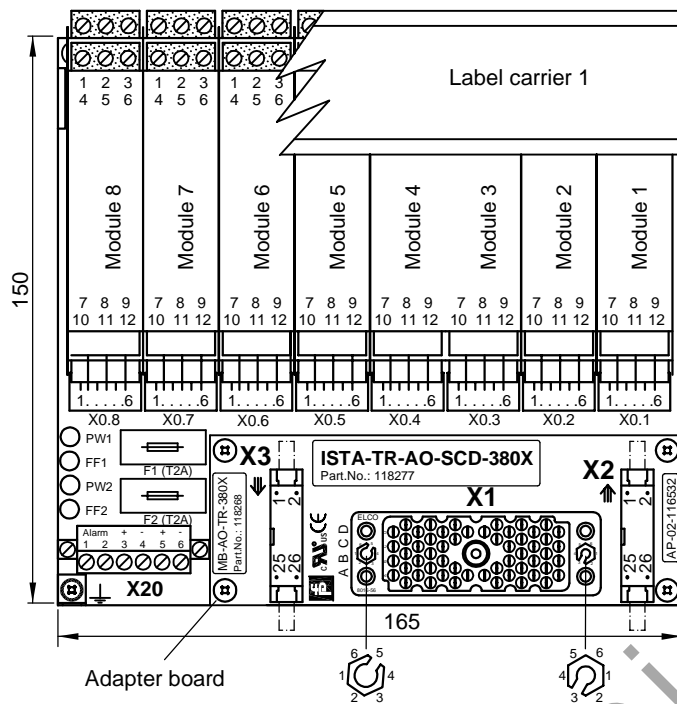

**APPLICATION:**

**TRICONEX I/O card 3805E:**  
8 points

Name	Note
X1	56 pin female system connector ELCO (small key: 3, large key: 5)
X2, X3	26 pin HART connector male
X0.1 .... 16	6 pin male terminals for cable tree FSY....
X20.3 .... 6	Power supply screw terminals
X20.1, X20.2	Alarm screw terminal
F1, F2	Fuse
PW1, PW2, FF1, FF2	LEDs for power and power failure

**Ordering information: ISTA-TR-AO-SCD-380X-118277**

Basic components:	Description
<b>8 pieces:</b> KFD2-SCD-Ex1.LK (AO)	KF-Module type (function)
<b>1 piece:</b> MB-AO-TR-380X-118268	Motherboard without modules
<b>composed by:</b>	
1 piece: MB-8U2-Y97680	Motherboard without modules, adapter board, FSY cable tree and Label carrier
1 piece: AP-02-116532	Adapter board
1 piece: KFD0-LC1-8M-99143	Label carrier 1
16 pieces: FSY-L450-98833	Cable tree connection KF-Module-Motherboard

copyright according to DIN34  
unauthorized distribution and reproduction prohibited

	<b>PEPPERL+FUCHS</b> Mannheim-Schönau	Motherboard unit Analog Output - HART 8 channels <b>ISTA-TR-AO-SCD-380X</b>	14.03.02	KT	vB	vB/Sb	
			Date	S TZ	Off. in ch.	contr. techn.	contr. Norm
			Dept.: PA-VP	<b>Nr. 36-7464A</b>			
			Up date: 23.03.04	vB/Bro	Replaces: xxxxxx / 36-xxxx	Sheet 1	
			MB-8U2	Scale:	1 : 2	of 2	

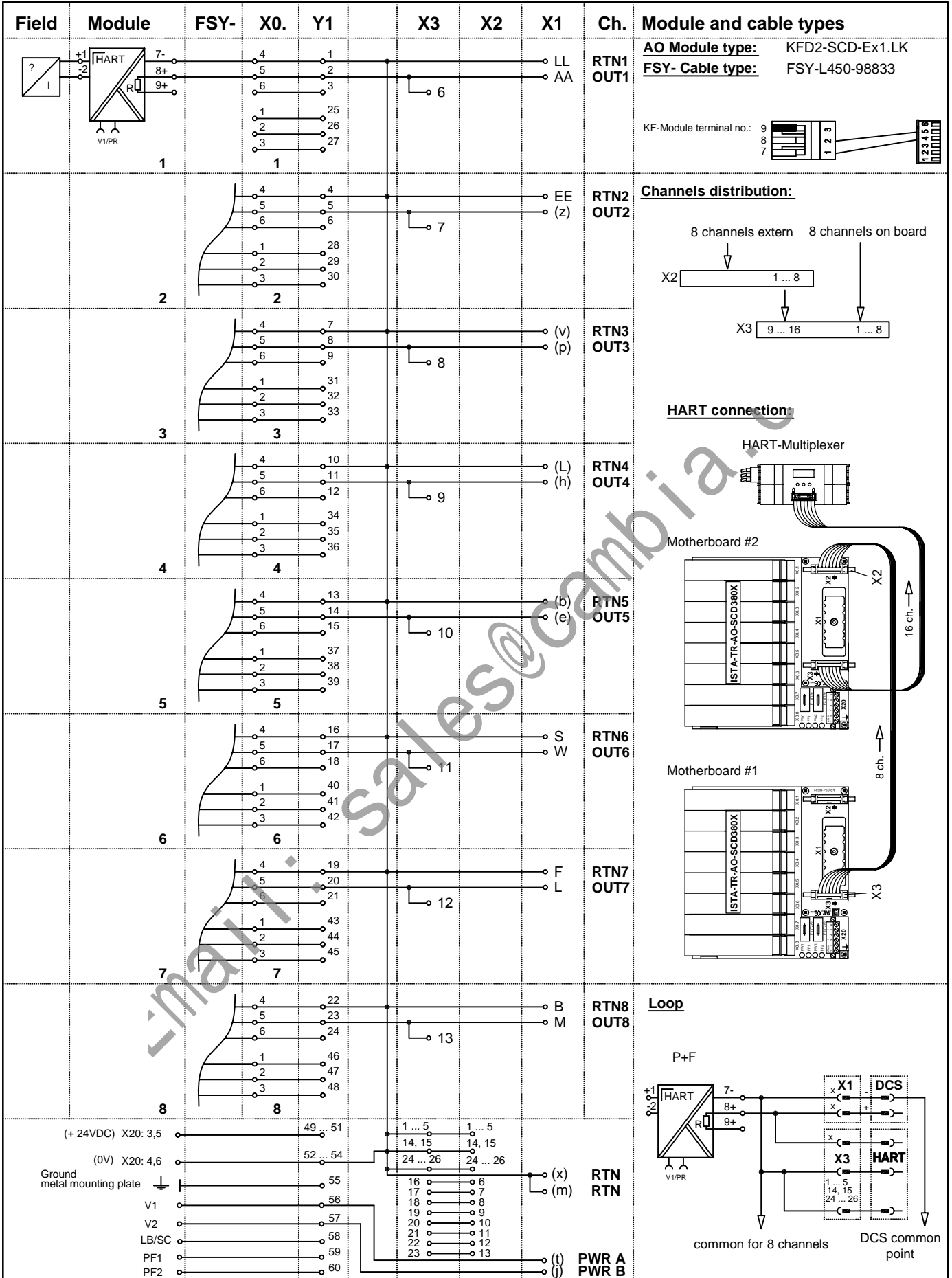

**PEPPERL+FUCHS**  
Mannheim-Schönau

Motherboard unit  
Analog Output - HART  
8 channels  
**ISTA-TR-AO-SCD-380X**

22.03.02	KT	vB	Sb/vB	
Date	S TZ	Off. in ch.	contr. techn.	contr. Norm
Dept.: PA-VP	Nr. <b>36-7464A</b>			
Up date: 22.10.04	Sb	Replaces: xxxxx / 36-xxxx	Sheet 2	
	Scale:		of 2	



## 11. Cabinet assembly

	Page
Cabinet assembly with Motherboard and HART 320 I / O.....	11- 1
Cabinet assembly with Motherboard, marshalling and redundant power supply .....	11- 2

Email: [sales@cambia.com](mailto:sales@cambia.com)

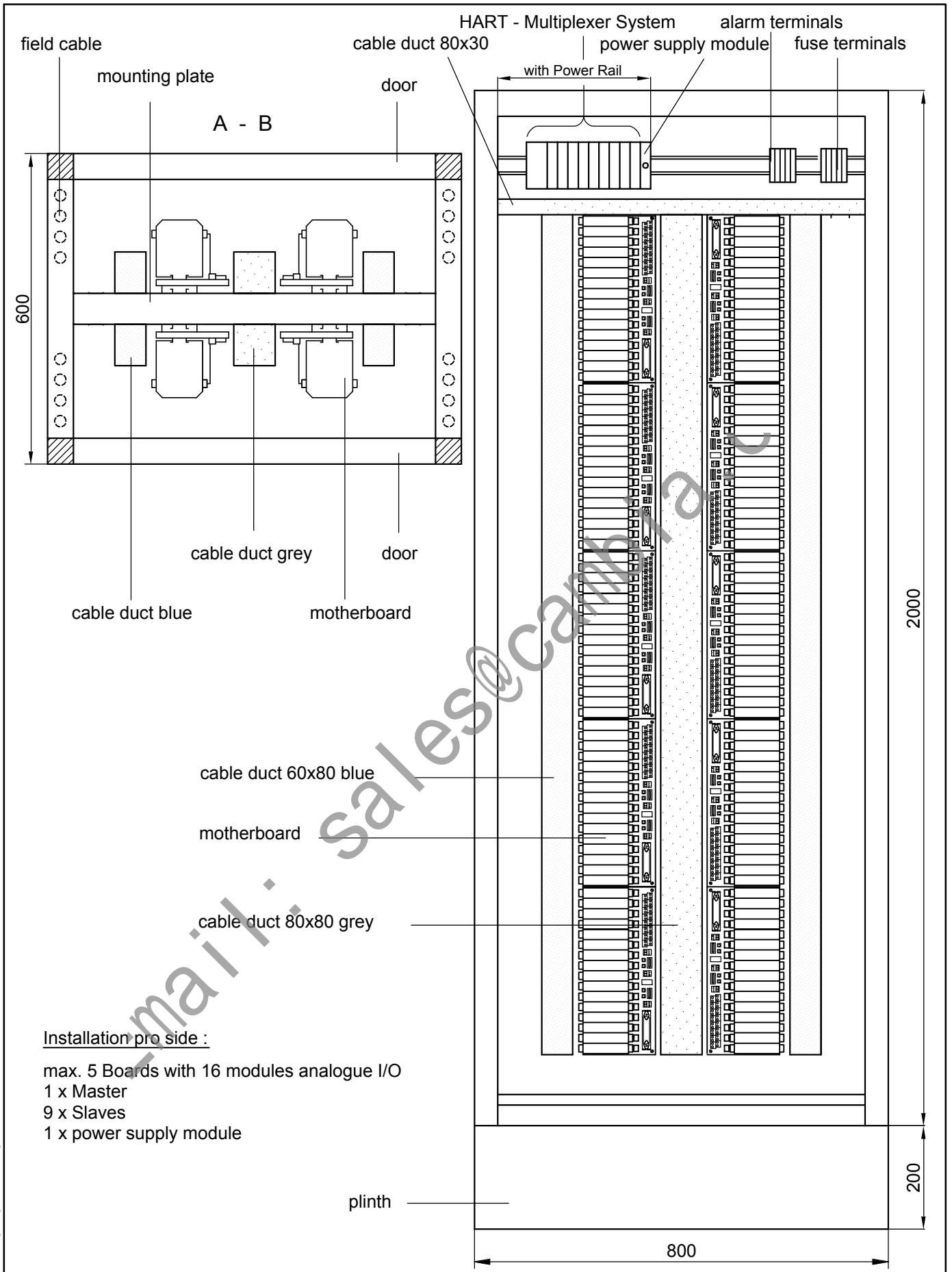

Installation pro side :

- max. 5 Boards with 16 modules analogue I/O
- 1 x Master
- 9 x Slaves
- 1 x power supply module

		14.09.98		AJ		vB	
Ind.	Änderung	Datum	S	TZ	Sach- bearb.	gepr. techn.	gepr. Norm
 <b>PEPPERL+FUCHS</b> Mannheim-Schönau		cabinet assembly with motherboards and HART - Multiplexer for 320 Input / Output			Abt.:	Nr. TAB157	Ind. TR
					Part.Nr.:	Ersatz für:	Blatt
					Maßstab: 1 : 10	von	

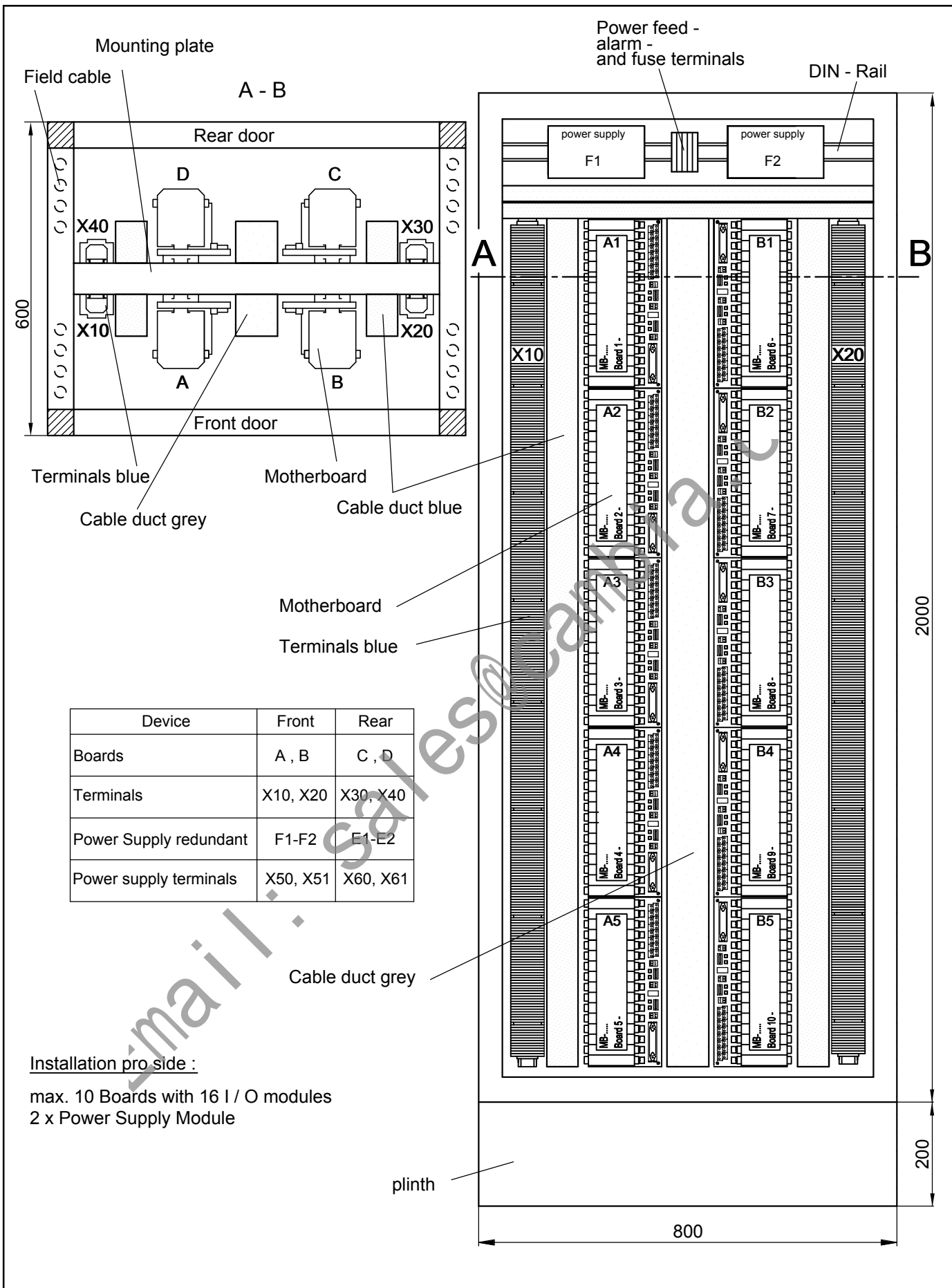

Device	Front	Rear
Boards	A , B	C , D
Terminals	X10, X20	X30, X40
Power Supply redundant	F1-F2	E1-E2
Power supply terminals	X50, X51	X60, X61

Installation pro side :

max. 10 Boards with 16 I / O modules  
2 x Power Supply Module

Urheberschutz nach DIN 34  
Weitergabe sowie Vervielfältigung ist nicht gestattet

<b>PF</b>	<b>PEPPERL+FUCHS Mannheim-Schönau</b>	Cabinet assembly for max. 320 I / O with motherboards , marshalling and redundant Power Supply	14.09.98		AJ	AJ	AJ	
			Datum	S	TZ	Sach- bearb.	gepr. techn.	gepr. Norm
			Abt.: PA-VP		Nr. TAB174		Ind. TR	
			Part.Nr.:		Ersatz für:		Blatt 1	
					Maßstab: 1 : 10		von 1	

## 12. Accessories

	Page
Label Carrier .....	12- 1
Sheidling busbar .....	12- 2

Email: [sales@cambia.a.c](mailto:sales@cambia.a.c)

# Label Carrier

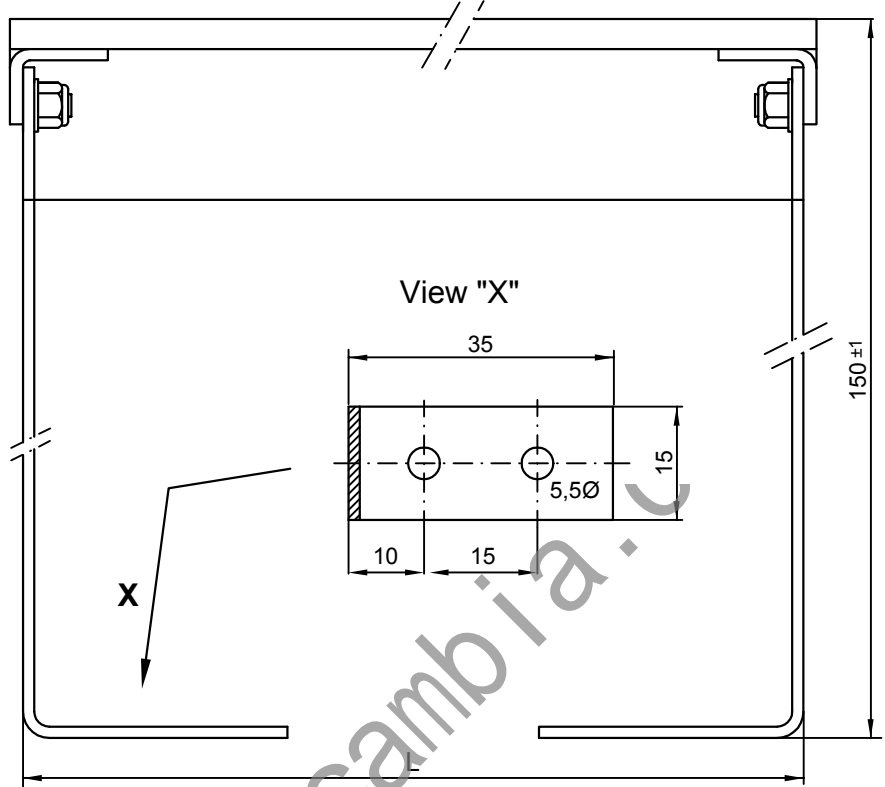
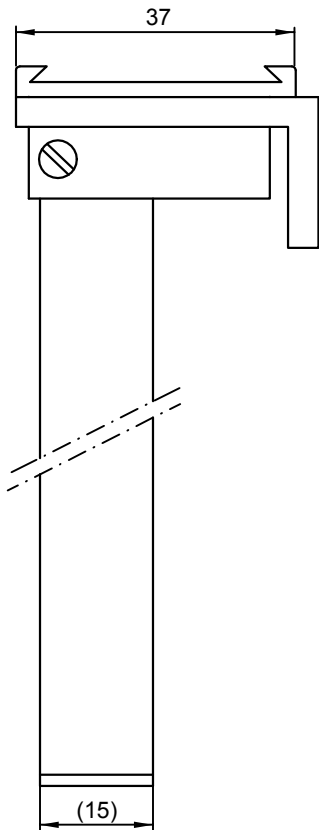

Customer marking area:  
pro module 29mm x 20mm

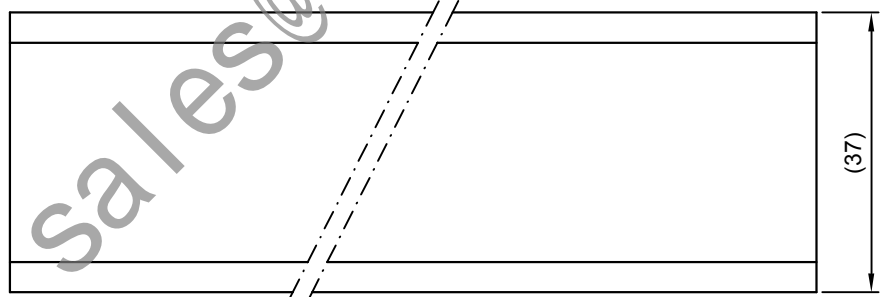

Label Carrier KFD0-LC-...			
L	Part.-No.	Name	Note
up to 50 cm	108878	KFD0-LC1-x-xxxxx	(*) customized (XXX = length in cm)
51 to 100 cm	108879	KFD0-LC1-x-xxxxx	(*) customized (XXX = length in cm)
(*) in case of order; delivery time 2-4 weeks			

copyright according to DIN34  
unauthorized distribution and reproduction prohibited

		29.01.01		DN	vB	Sb/vB	
		Date	S	TD	Off. in ch.	contr. techn.	contr. Norm
 <b>PEPPERL+FUCHS</b> Mannheim-Schönau	<b>Label Carrier</b>	Dept.: PA-VP	No. <b>36-9146</b>		Ind. <b>B</b>		
		Up date: 13.08.01	A: vB/MB	Replaces:	Sheet 1		
			xxxxxx / 36-xxxx	of 1			
		Scale: 1 : 1					

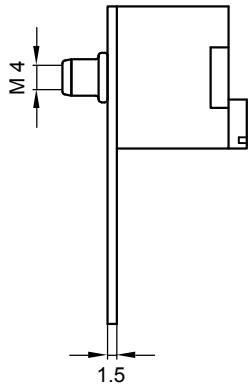
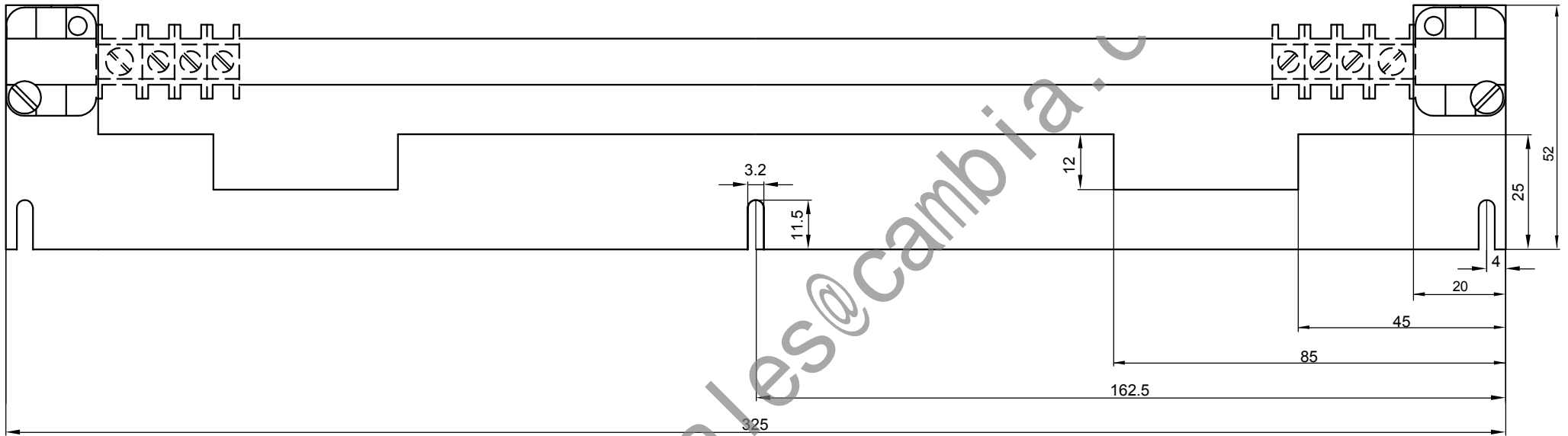

email: sales@cambia.com

12-2

A : vB		09.09.99		MB		MB	
Ind. Änd.		Date	S	TZ	Off. in ch.	contr. techn.	contr. Norm
 PEPPERL+FUCHS Mannheim-Schönau	Motherboard - Sheidling busbar for 16 Modules <b>MBE-16-Y44009</b>	Dept.: PA - VP	Nr. 36-9093		Ind. A		
		Part no.:	Replaces:		Sheet		
		MB U4	Scale:	1 : 1		of	

## 13. Test certificate

	Page
Test certificate.....	13- 1

Email: [sales@cambia.a.c](mailto:sales@cambia.a.c)

Notes:

This catalogue contains only the Motherboards specified in the agreement with Invensys.

Further Motherboards with different functions are available on request.

Email: [sales@cambia.a.c](mailto:sales@cambia.a.c)



(Proposal)

## Test certificate

On June 15<sup>th</sup> 1999 have been tested succesfully the Pepperl+Fuchs Interface-Boards with Triconex I/O cards. Type names of each device see table below.

**It was a 100 % test. Each channel was tested by connecting the accordingly signal to the field side of P+F modules and was shown by a test programme on Triconex system monitor.**

Triconex I/O card	P+F Motherboard	P+F module	Signal
3503E / 3505E * <sup>2)</sup>	ISTA-TR-DI-350X-118289	KFD2-SH-Ex1.T.OP (1-channel module)	32 point. Digital Input 24 V DC
	ISTA-TR-DI-SRLB-350X-122110	KFD2-SR2-Ex1.W.LB (1-channel module)	16 point. Digital Input 24 V DC
	ISTA-TR-DI-SR2-350X-118271* <sup>1)</sup>	KFD2-SR2-Ex2.2S (2-channel module)	16 + 16 point. Digital Input 24 V DC
	ISTA-TR-DI-SR2-350X-118272* <sup>1)</sup>	KFD2-SOT2-Ex2 (2-channel module)	16 + 16 point. Digital Input 24 V DC
3504E / 3564 * <sup>2)</sup>	ISTA-TR-DI-SR2-35XX-118278	KFD2-SR2-Ex2.2S (2-channel module)	32 + 32 point. Digital Input 24 V DC
	ISTA-TR-DI-SOT2-35XX-118279	KFD2-SOT2-Ex2 (2-channel module)	32 + 32 point. Digital Input 24 V DC
3511	ISTA-TR-DI-350X-118289	KFD2-SH-Ex1.T.OP (1-channel module)	32 point. Digital Input 24 V DC
3604E	ISTA-TR-DO-SD-36XX-118274	KFD2-SD-Ex1.48... (1-channel module)	16 point. Digital Output 24 V DC
	ISTA-TR-DO-SL2-36XX-118273	KFD2-SL2-Ex2.B (2-channel module)	16 + 16 point. Digital Output 24 V DC
	ISTA-TR-DO-SL2-36XX-118288	KFD2-SL2-Ex2 (2-channel module)	16 point. Digital Output 24 V DC
3664 * <sup>2)</sup>	ISTA-TR-DO-SD-36XX-118274	KFD2-SD-Ex1.48... (1-channel module)	16 + 16 point. Digital Output 24 V DC
	ISTA-TR-DO-SL2-36XX-118273	KFD2-SL2-Ex2.B (2-channel module)	32 point. Digital Output 24 V DC
	ISTA-TR-DO-SL2-36XX-118288	KFD2-SL2-Ex2 (2-channel module)	32 point. Digital Output 24 V DC
3700 / 3700A / 3701 * <sup>2)</sup>	ISTA-TR-AI-STC-370X-118275 Incl. 1 HART connector	KFD2-STC4-Ex1 (1-channel module)	16 + 16 point. Analog Input 0/4 ... 20 mA
	ISTA-TR-AI-UT-370X-118276 Incl. 1 HART connector	KFD2-UT-Ex1 (1-channel module)	16 + 16 point. Analog Input 24 V DC
3703E	ISTA-TR-AI-STC-370X-118275 Incl. 1 HART connector	KFD2-STC4-Ex1 (1-channel module)	16 point. Analog Input 0/4 ... 20 mA
	ISTA-TR-AI-UT-370X-118276 Incl. 1 HART connector	KFD2-UT-Ex1 (1-channel module)	16 point. Analog Input 24 V DC
3704E * <sup>2)</sup>	ISTA-TR-AI-STC-370X-118290 Incl. 2 HART connector	KFD2-STC4-Ex1 (1-channel module)	32 point. Analog Input
3805E	ISTA-TR-AO-SCD-380X-118277 Incl. 2 HART connector	KFD2-SCD-Ex1.LK (1-channel module)	8 point. Analog Output 4 ... 20 mA

\*<sup>1)</sup> Motherboard with two pick off (see Datasheet 36-7169, 36-7413)

\*<sup>2)</sup> I/O card requieres 2 Boards

Irvinie (Date)

Mannheim (Date)

Stamp/Signature

Stamp/Singnature